

PATIO XXS THERMO SAUNA





















INSTALLATION MANUAL

Instructions

1. It is recommended to install the sauna above ground level to prevent the base frame of the sauna from coming into direct contact with the ground. Install a water-resistant material, such as bitumen strips, between the base frame and the base surface.
2. Make sure that the surface on which you install the sauna is level and stable before and after installing the sauna. Otherwise, the doors of the sauna may not open and close properly later on.
3. During the first heating of the sauna, it must be constantly supervised, and the doors should be kept open, as the stove emits a specific odor when first heated. Read more from the user manual for the sauna stove.
4. The maximum permitted temperature in the steam room is +90 °C. If heated to a higher temperature, the sauna may become overheated.
5. In order to avoid damage caused by the weight of snow in winter, any snow should be removed from the roof of the sauna. Keep in mind that the roof covering should not be damaged during snow removal.
6. If your sauna has lighting, install a 3G 2,5 mm outdoor power cable and connect it in accordance with the schematics on the plug socket coupler provided with the sauna. The power cable of the sauna must be connected to a residual-current circuit breaker! Consult an electrician if necessary.

Required tools

	Tape measure		Cutting knife		Respirator
	Pencil		Battery drill		Scissors
	Level		Nail gun		Tin shears
	Rubber mallet		Circular saw		Pliers
	Hammer		Gloves		Hole saw Ø 100 mm
	Hand saw		Safety goggles		Jigsaw

Floor plan

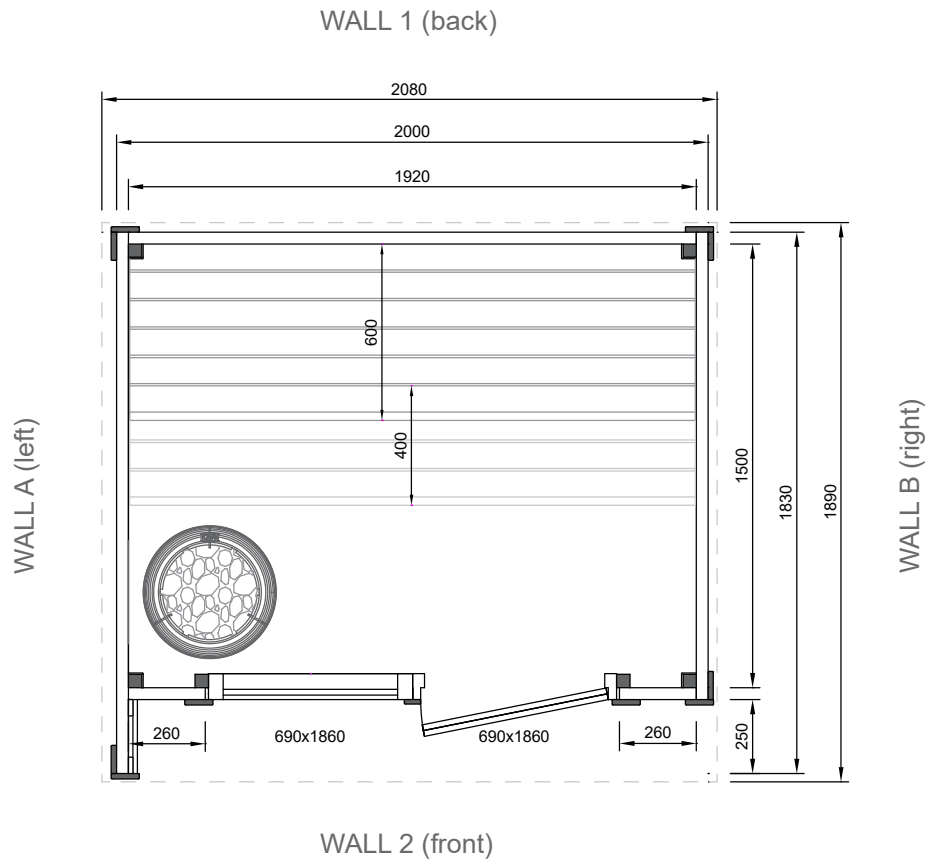

Cross section

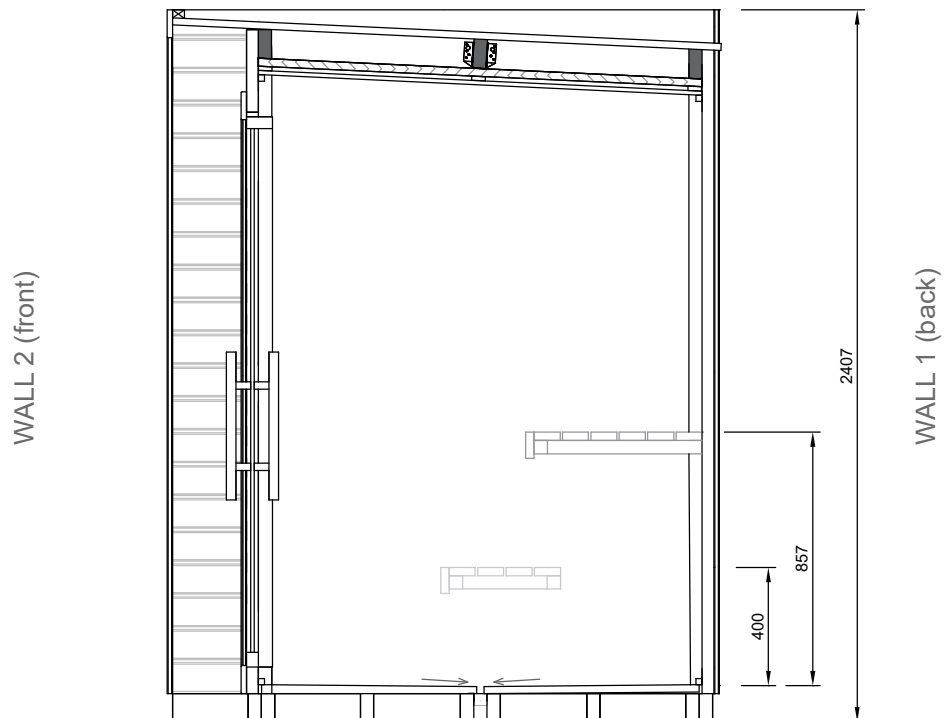

STEP 1 - Base frame

Marking	Detail	Image	Note	Length	Pcs.
AR-1	45x95 Base Frame			1900	8
AR-2	45x95 Base Frame			1825	1
AR-3A	45x95 Base Frame		<i>Cutout!</i>	1570	1

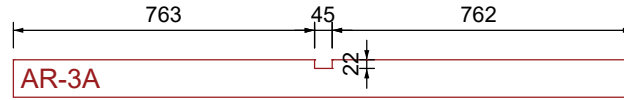

VR-1	Drainage detail			2000	1
------	-----------------	--	--	------	---

Marking	Detail	Image	Note	Length	Pcs.
	Screw 5x90		for base frame		40

1.1 Connect the base frame details according to Scheme 1.1.

Make sure that the frame is level and that the diagonals are equal ($X = Y$). Leave a 45 mm gap between two AR-1 base frame details so that the water drainage detail VR-1 can be fitted between them.

Use a level, a battery drill, and 5x90 screws to join the base frame together.



1.2 Place the VR-1 drainage detail on top of the base frame.

No fixings are needed.

Caution! The detail has sharp edges; use gloves.



Check diagonals: $X=Y$



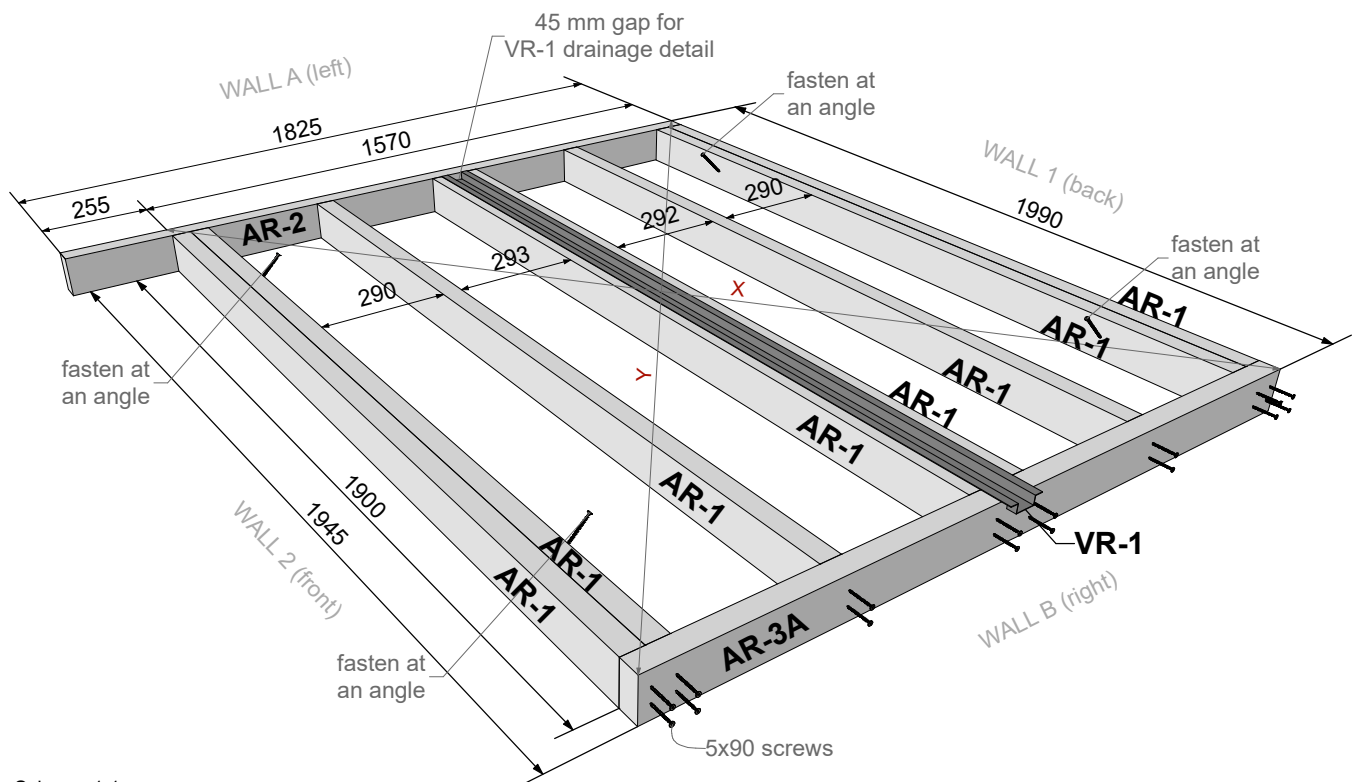

$X= 2535$ mm

$Y= 2535$ mm

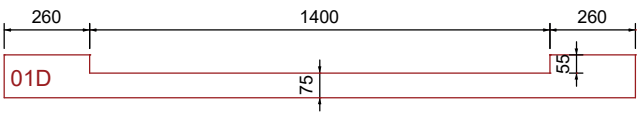

Scheme 1.1

STEP 2 - Walls

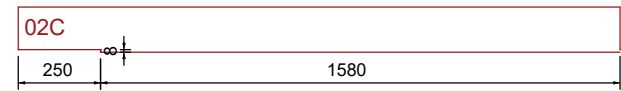
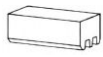
Marking	Detail	Image	Note	Length	Pcs.
01	40x138 Wall Log Thermo			1920	19
EXTRA	40x138 Wall Log Thermo			1920	1
01B	40x96 Wall Log Thermo		<i>Height: 96 mm</i>	1920	1
01C	40x34 Wall Log Thermo		<i>Height: 34 mm</i>	1920	1
01D	40x138 Wall Log Thermo		<i>Cutout!</i>	1920	1
					
02	40x138 Wall Log Thermo			1830	17
02B	40x102 Wall Log Thermo		<i>Height: 102 mm</i>	1830	1
02C	40x138 Wall Log Thermo		<i>Height: 102 mm, Cutout!</i>	1830	1
					
03	40x138 Wall Log Thermo			1580	17
04	40x138 Wall Log Thermo			260	28
EXTRA	40x138 Wall Log Thermo			260	4
	Hitting Block				2
P-1	45x45 Corner Post			2190	2
P-2	45x45 Corner Post			2120	2
AT-1	45x45 Temporary Support			~1800	8
Marking	Detail	Image	Note	Length	Pcs.
	Screw 6x180		for every wall log		200
	Screw 4.5x70		for corner posts		270
	Screw 4.5x70		for temporary supports		16

STEP 2 - Walls

- 2.1 Place the first row of wall logs on the base frame according to Scheme 2.1. Make sure that the wall logs protrude 5 mm outward from the base frame on all sides. Use 6x180 screws to fix the wall logs to the base frame.
Suggestion: Pre-drill the holes for the screws to prevent wall logs from splitting.

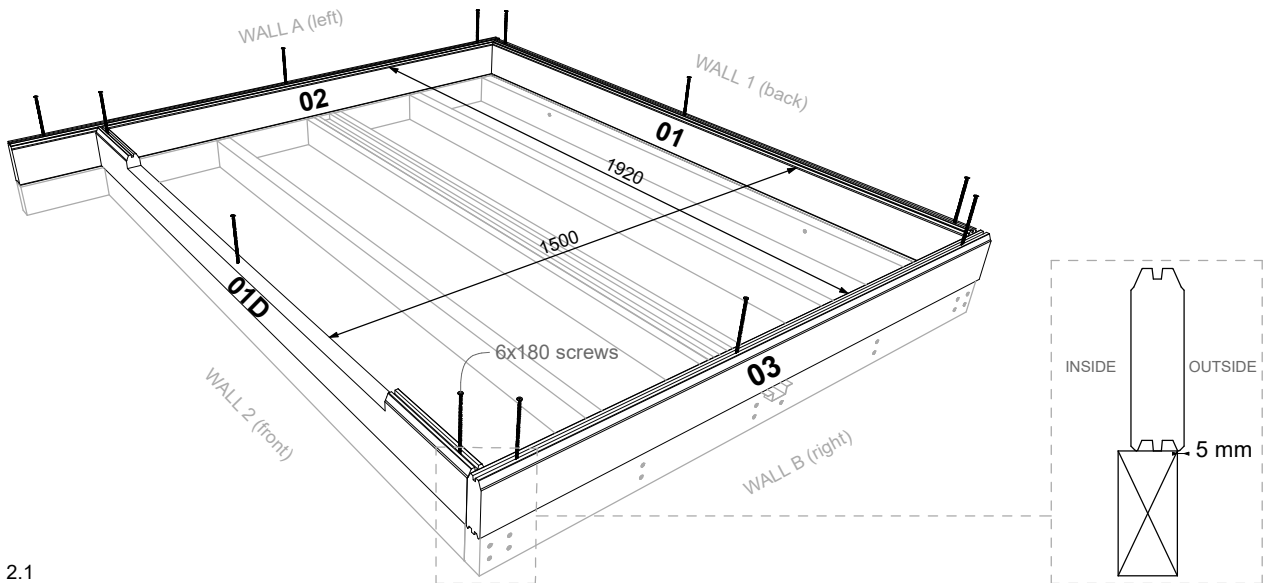
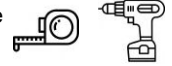

Scheme 2.1

- 2.2 Place the second row of wall logs on top of the first row. Use a hitting block and a rubber mallet to set the logs in place. Attach the second row to the first using 6x180 screws and a battery drill.
Suggestion: Pre-drill the holes for the screws to prevent wall logs from splitting.



- 2.3 Install corner posts in the inner corners. Leave a 45 mm gap at the bottom, between the corner posts and the base frame. Use 4.5x70 screws and a drill to fix the corner posts to every wall log (Scheme 2.2).
Suggestion: Pre-drill holes for the screws to prevent the posts from splitting.



- 2.4 Vertically level the corner posts and temporarily attach AT-1 details to them for support and to keep the posts in a level position. Use a level, 4.5x70 screws, and a battery drill.

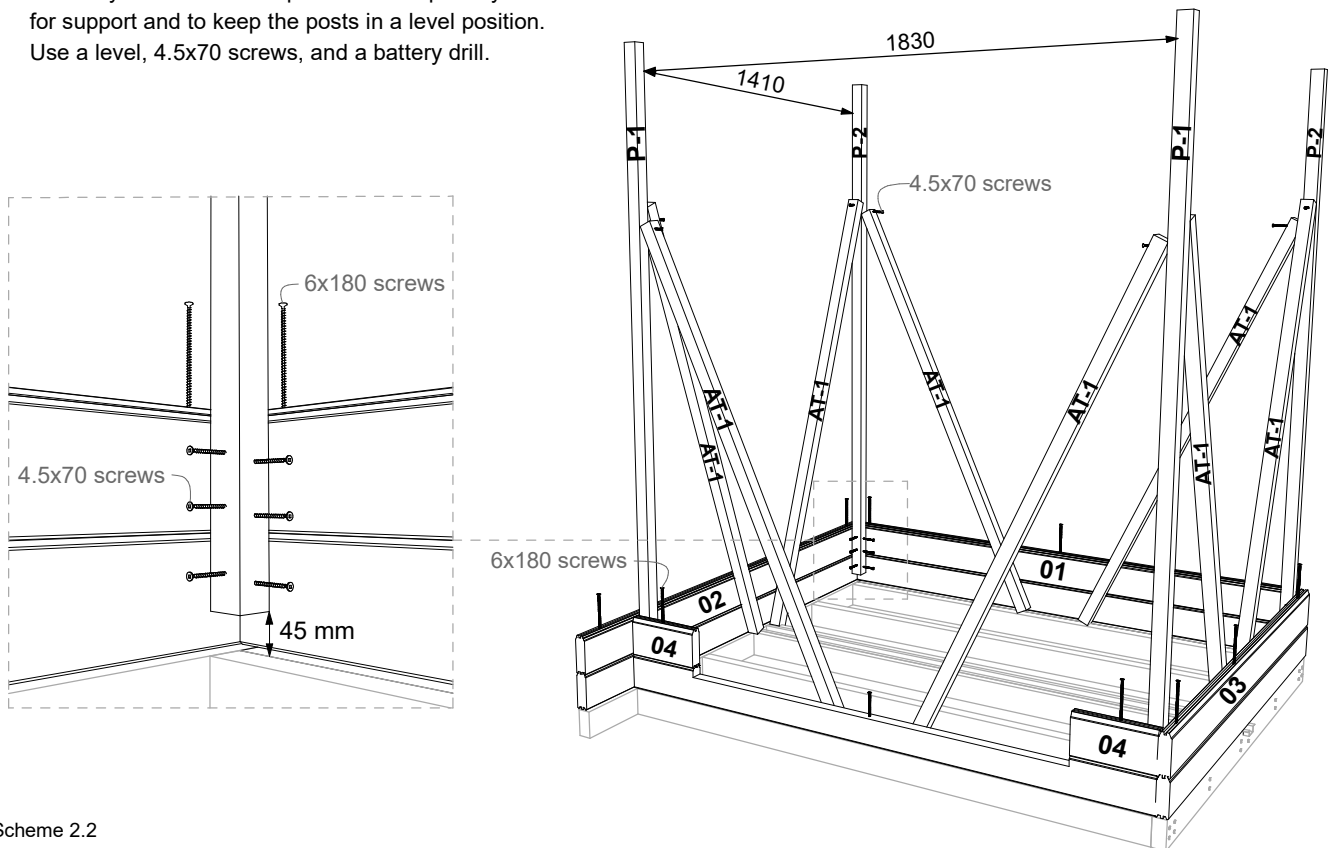

Scheme 2.2

STEP 2 - Walls

2.5 Continue to install the wall logs on top of each other according to the "Wall Layout" scheme on page 7. Use 6x180 screws to connect all wall logs to each other and 4.5x70 screws to fix all logs to corner posts, like shown in Scheme 2.3.



2.6 Remove the AT-1 temporary support details after all wall logs have been installed.

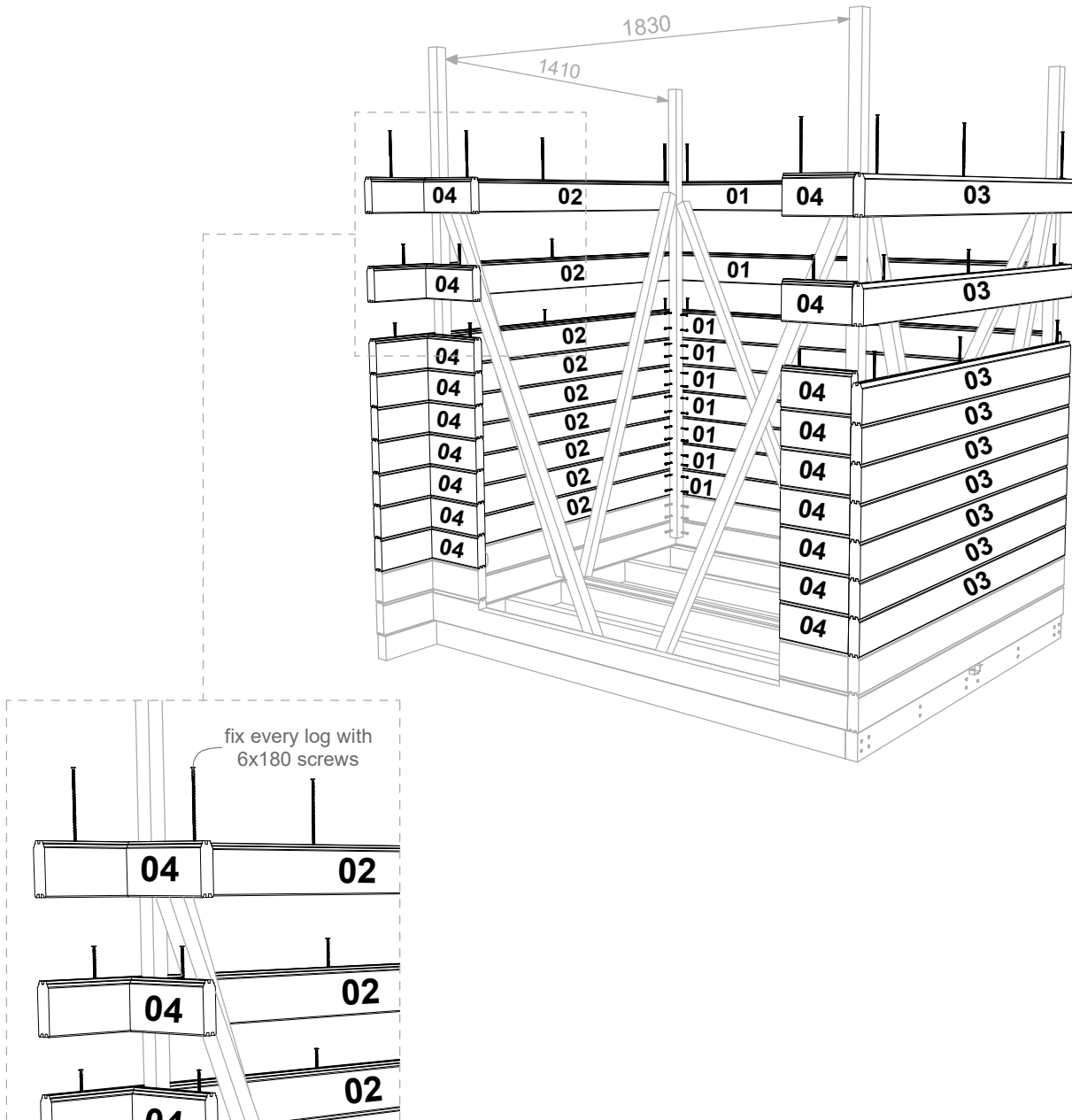

Scheme 2.3

For installation of walls, please see the placement of the wall logs on the "Wall Layout" scheme on page 7.

WALL LAYOUT

* Connect all wall logs together using 6x180 screws.

* Connect all wall logs to corner posts using 4.5x70 screws

Wall 2 (front)

View from the outside

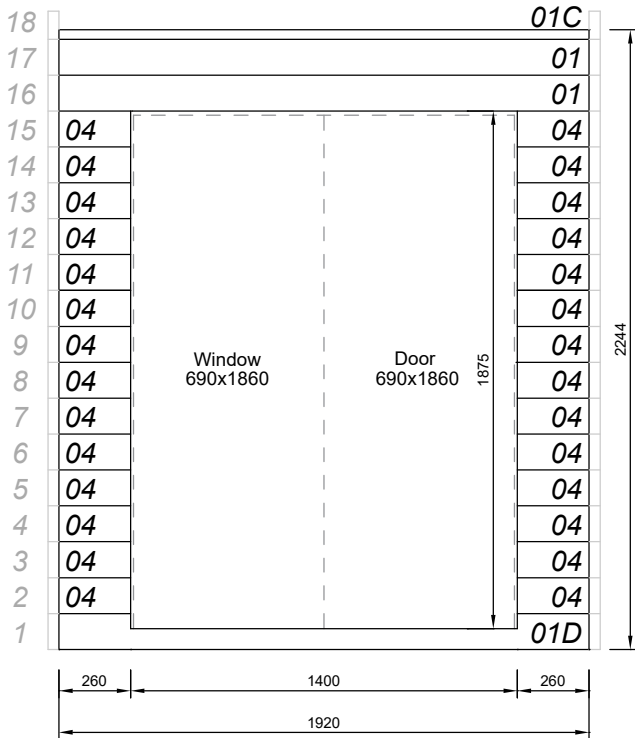

Wall A (left)

View from the outside

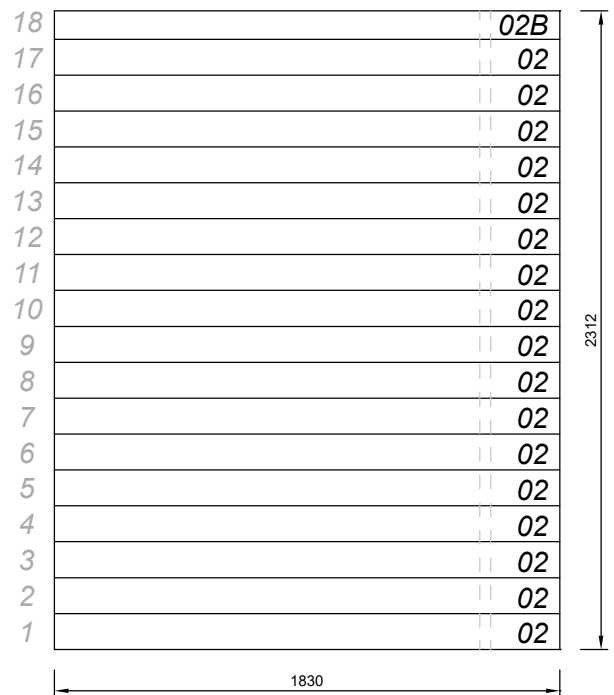

Wall 1 (back)

View from the outside



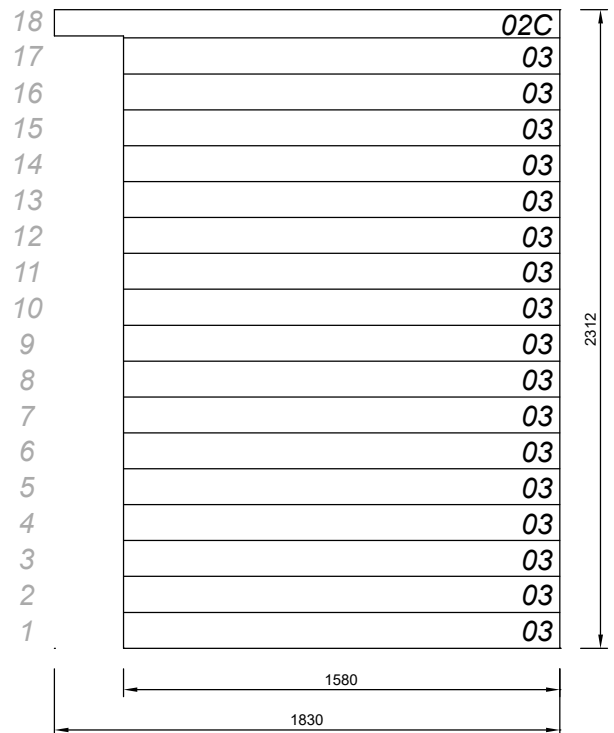

Wall B (right)

View from the outside



STEP 3 - Roof boards and ceiling

Marking	Detail	Image	Note	Length	Pcs.
KL-1	24x120 Roof Board			1850	18+2
01F	40x30 Roof Block			1920	1
T-1	45x95 Ceiling Beam			1918	1
T-2	45x95 Ceiling Beam			1825	2
DI-2	15x55 Ceiling Distance Board			1915	1
DI-3	15x55 Ceiling Distance Board			1825	2
	SPU Insulation Panel 30x600x1200				5
STP-1	15x90 Ceiling Board		<i>Thermo spruce</i>	1495	24+2

Marking	Detail	Image	Note	Length	Pcs.
	Joist Hanger 45x97		for fixing T-1 beam		2
	Screw 5x40		<i>for joist hangers</i>		20
	Screw 4.5x70		<i>for T-2 beams & distance boards</i>		25
	Screw 3.5x50		<i>for 01F roof block</i>		5
	Nail 70 mm		<i>for KL-1 roof boards</i>		150
	Lost-head nail 40 mm		<i>for STP-1 ceiling boards</i>		100
	Foil Tape		for SPU insulation panels	10 m	2

3.1 Attach the T-2 beams to the front and back walls. Leave ~2 mm gap at both ends. Make sure that the top side of the beam is flush with the upper edge of the front and back walls. Use 4.5x70 screws and a drill to fix the beams to the walls (Scheme 3.1).

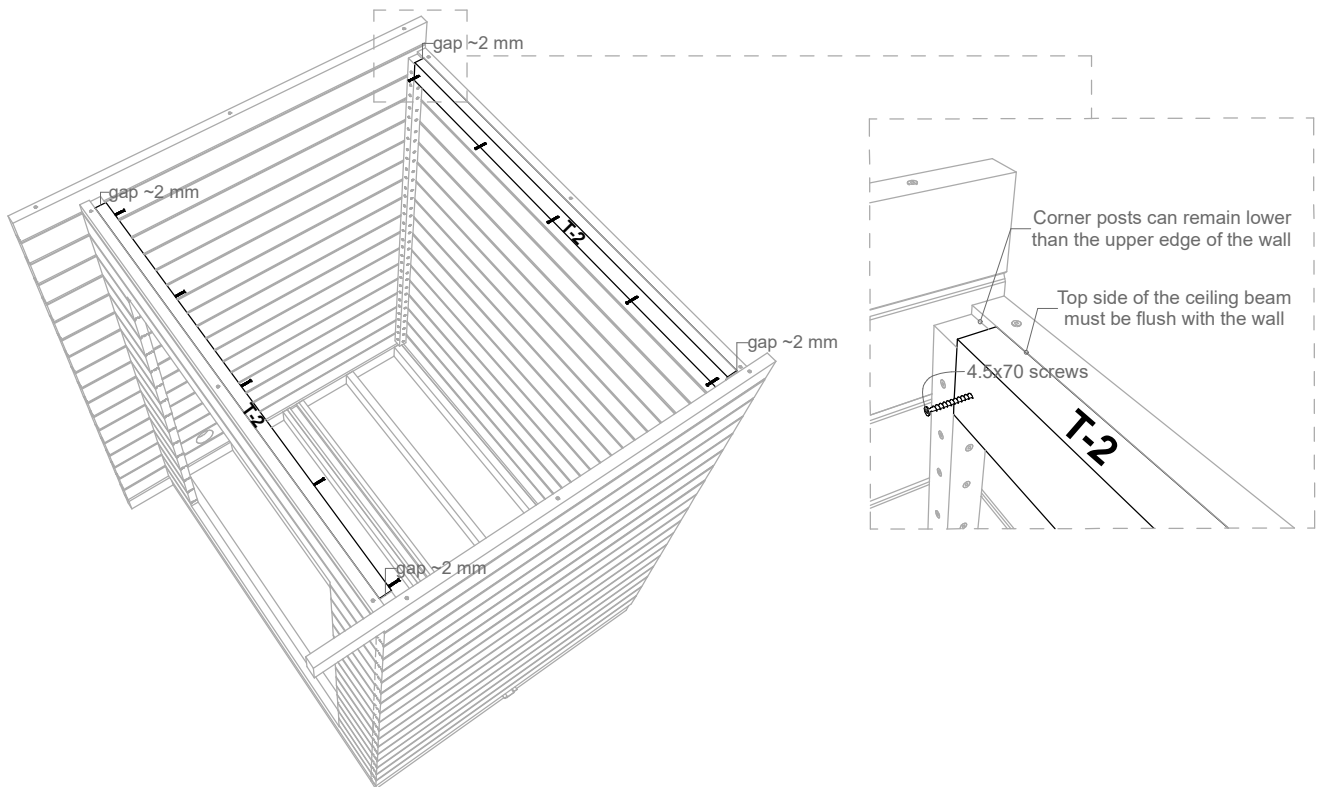

Scheme 3.1

STEP 3 - Roof boards and ceiling

- 3.2 Temporarily lay one KL-1 roof board or some other straight detail on top of the front and back walls. Mark the diagonal that forms under the detail on the side walls with a pencil. These markings will determine the installation height of the T-1 ceiling beam. Measure out the distance from the T-2 beams and mark the locations on both side walls, like shown in Scheme 3.2. These markings will indicate the spacing between the ceiling beams.

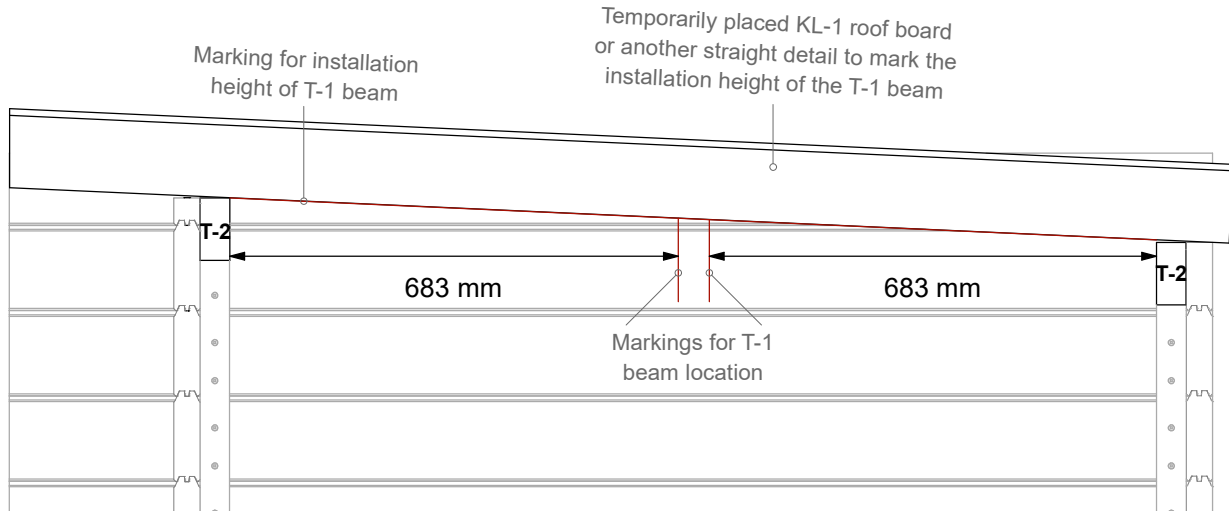
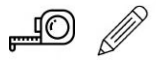

Scheme 3.2

- 3.3 Attach the joist hangers to the T-1 ceiling beam, flush with the beam ends. Use 5x40 screws.



- 3.4 Fasten the T-1 ceiling beam to the side walls through the joist hangers in the previously marked location, like shown in Scheme 3.3. Use 5x40 screws to fix the joist hangers to the beam and the walls.

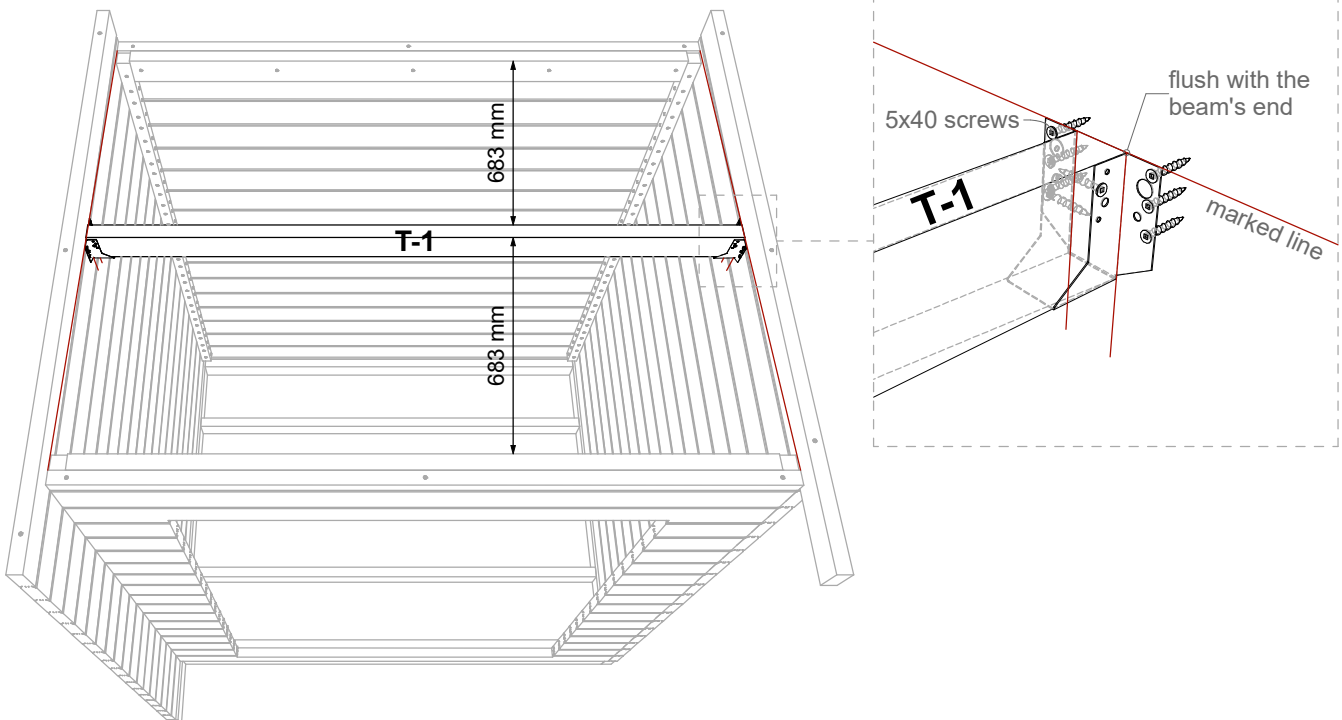

Scheme 3.3

STEP 3 - Roof boards and ceiling

- 3.5 Install the roof boards flush with the side walls, starting from the right. Fix the roof boards with 70 mm nails to the beams (6 nails per every roof board) with a hammer or a nailgun. Cut the last roof board to width using a circular saw.
- 3.6 When all the roof boards are installed, fasten the 01F roof block on top of the roof boards, flush with the front edge, like shown in Scheme 3.4. Use 3.5x50 screws for fixing.

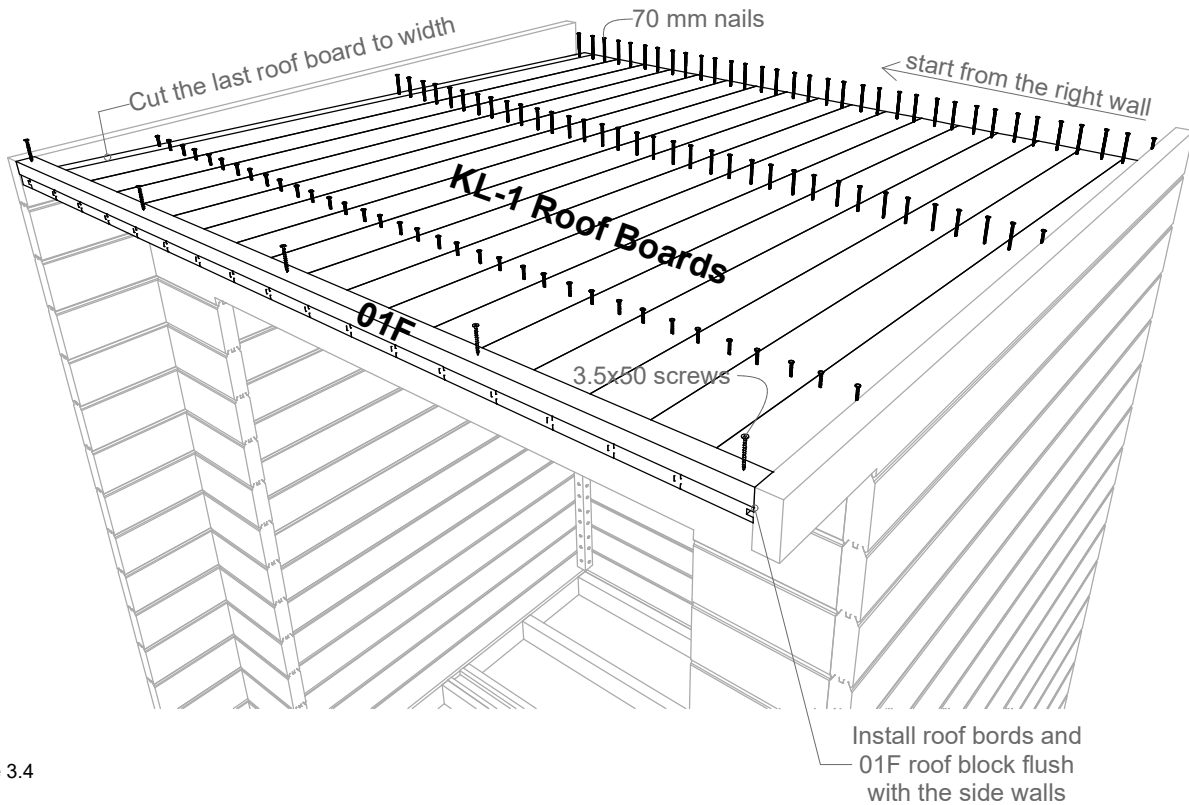

Scheme 3.4

- 3.7 Cut the SPU insulation panels to the right size using a cutting knife. Make cutouts in the corners for corner posts. Attach the panels to the ceiling beams using a few 4.5x70 screws. Tape all edges and joints with foil tape to prevent heat loss, like shown in Scheme 3.5.

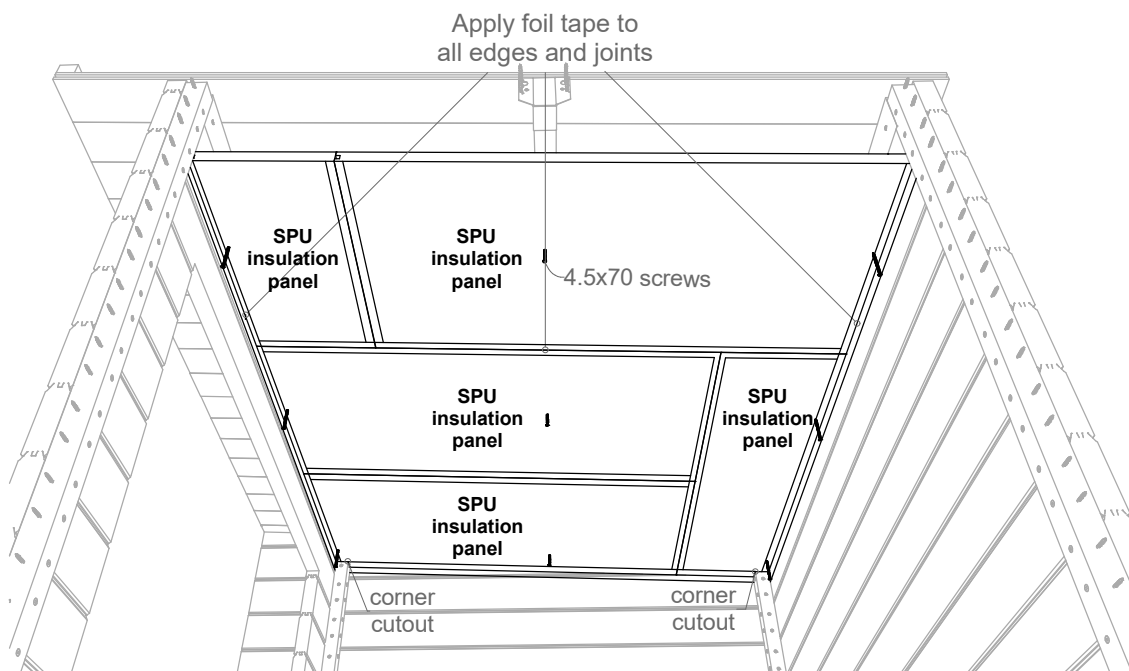

Scheme 3.5

STEP 3 - Roof boards and ceiling

3.8 Place the DI-2 and DI-3 ceiling distance boards on top of the insulation panels and fasten them to the ceiling beams using 4.5x70 screws.



3.9 Install the ceiling lining boards. Leave ~3 mm gap between the ceiling boards and walls on all sides. Use 40 mm lost-head nails (3 per every ceiling board) and a hammer or nail gun for fixing. Make corner cutouts in the first and last ceiling boards for corner posts with a hand saw, and cut the last ceiling board to width using a circular saw (Scheme 3.6).

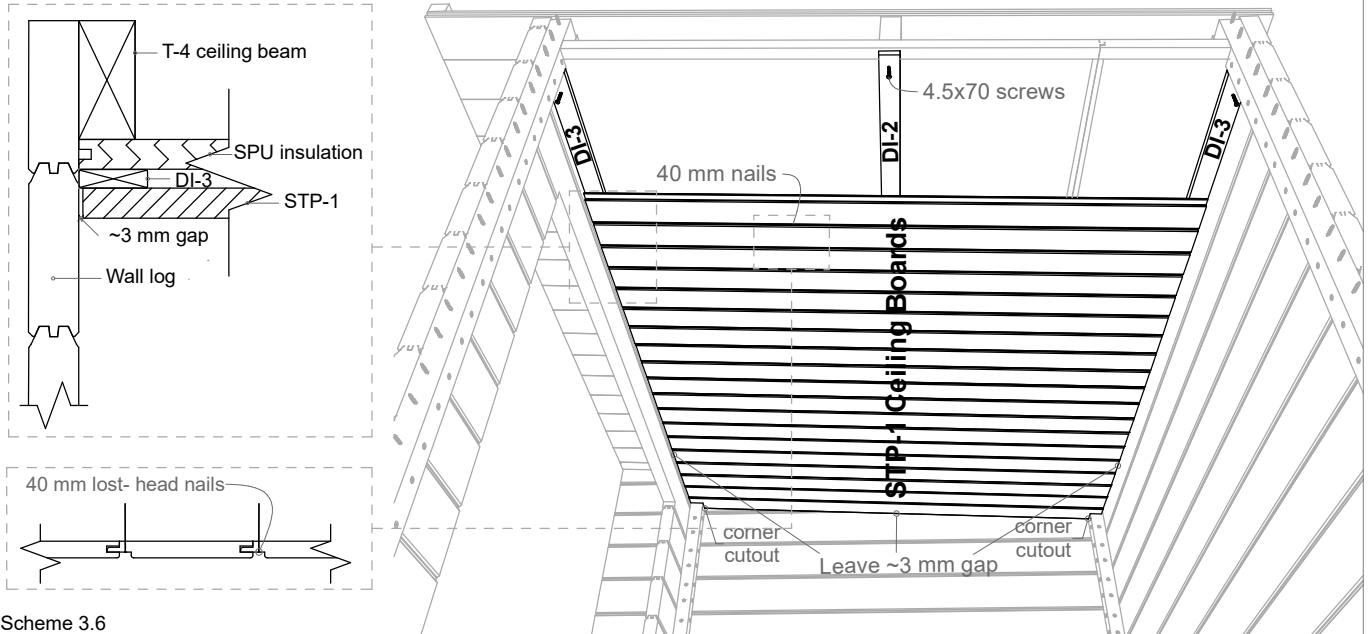

Scheme 3.6

STEP 4 - Floor

Marking	Detail	Image	Note	Length	Pcs.
	3 mm Floor slope veneer			1900	2
	6 mm Floor slope veneer			1900	2
PL-1	24x120 Floor Board			730	36+2
Marking	Detail	Image	Note	Length	Pcs.
	Screw 3.5x50		for floor boards		110

4.1 Place the slope veneers on the base frame to give the floor a slope for water drainage. Fixing the details to the base frame with screws is optional (Scheme 4.1).

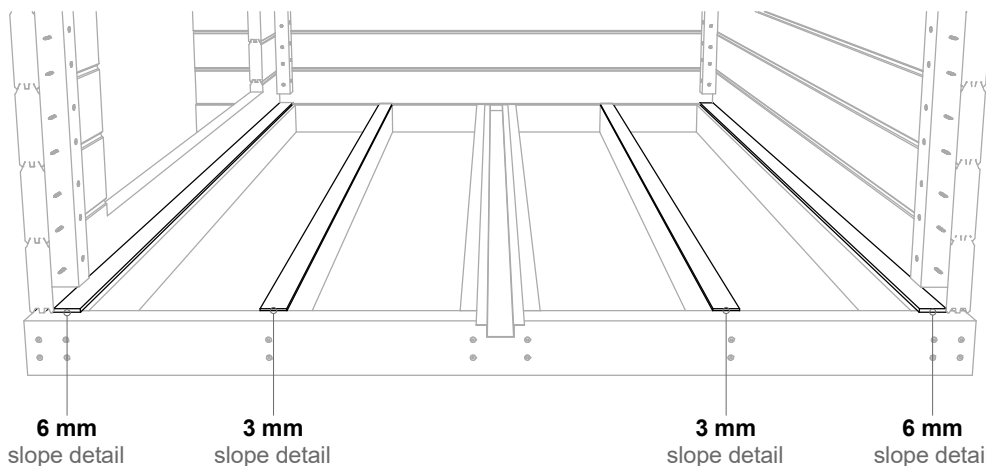

Scheme 4.1

STEP 4 - Floor

4.2 Install the floor boards starting from the right. Leave ~3 mm gap between the floor boards and walls at all sides. Cut the last floor board to width using a circular saw. Use 3.5x50 screws to fix the floor boards in place (Scheme 4.2).

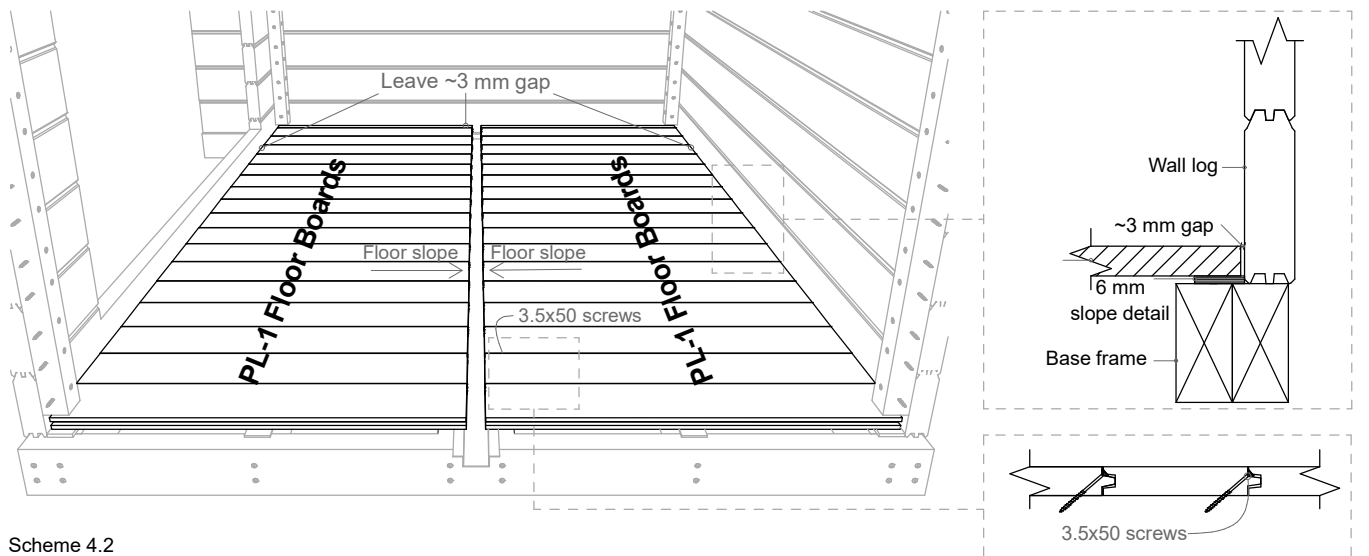

Scheme 4.2

STEP 5 - Doors and windows

Marking	Detail	Image	Note	Length	Pcs.
	Glass Door 88x690x1860		Metal + Wooden door handle		1
	Window 88x690x1860				1
UR-1	45x45 Door/ Window Frame			1950	2
UR-2	45x45 Door/ Window Frame			1380	2
	Screw 4.5x70		for door and window frames		40

5.1 Connect the door and window together by attaching the UR-1 and UR-2 frame details around them using 4.5x70 screws (Scheme 5.1). **Attention!** When installing the window, make sure that the inclined frame is located indoors, at the bottom of the window. The bottom side is marked with a sticker.



5.2 Lift and tilt the door and window diagonally into the opening (Scheme 5.2). Place them to their positions from inside the sauna. For easier installation, remove the glass from the door hinges to reduce the weight of the door.

5.3 Fix the door and window frames to Wall 2 (front) from the outside using 4.5x70 screws (Scheme 5.3). Attach the glass back to the door hinges and fix the door handles to the glass door so that the metal handle is located on the outside and the wooden handle on the inside. The difference in material can be detected by sound (tap on the handles).

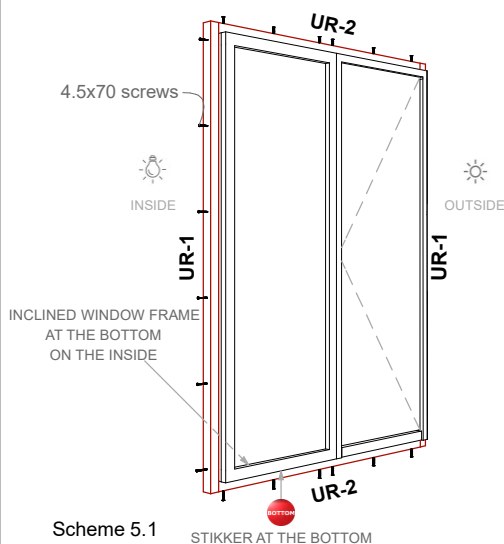

Scheme 5.1

STIKKER AT THE BOTTOM

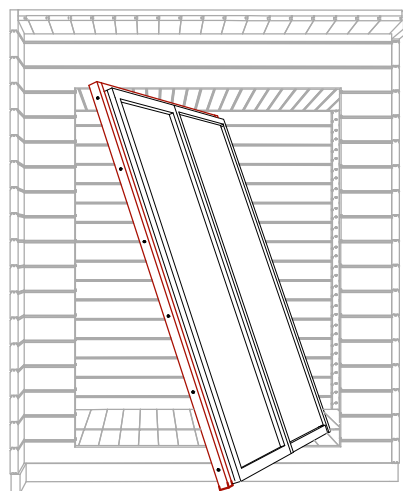

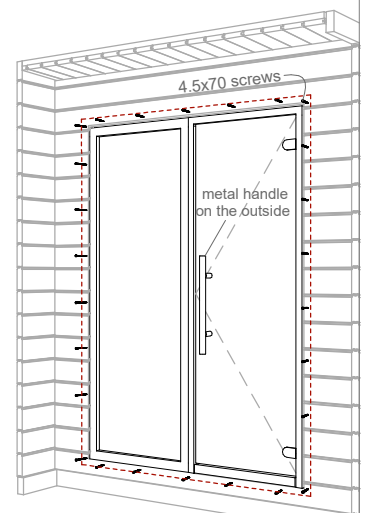

Scheme 5.2



Scheme 5.3

STEP 6 - Ventilation

Marking	Detail	Image	Note	Length	Pcs.
U-2	Ventilation Valve Ø100		wood		1
U-3	Ventilation Grid Ø100		metal		5
	Screw 3x40 Black				20

6.1 Cut the ventilation holes in the walls with a diameter of 100 mm using a hole saw or a jigsaw.
For recommended locations of ventilation openings see Scheme 6.1



Wall A (left)

View from the outside

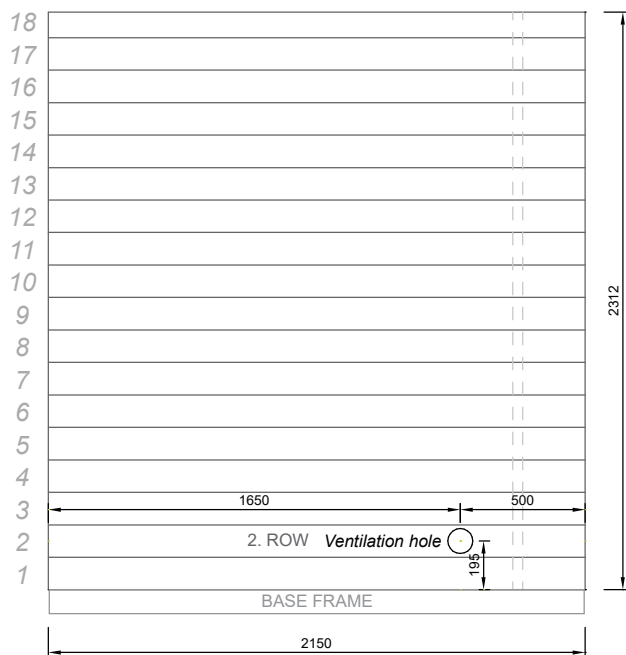

Wall 1 (back)

View from the outside

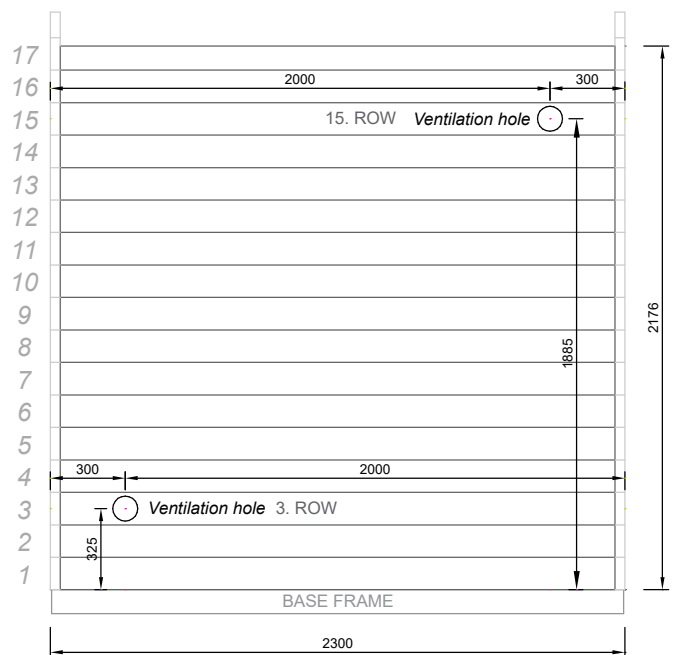

6.2 Cover the openings with ventilation grids or valves, as shown in Scheme 6.2. Use 3.5x40 black screws for fixing.

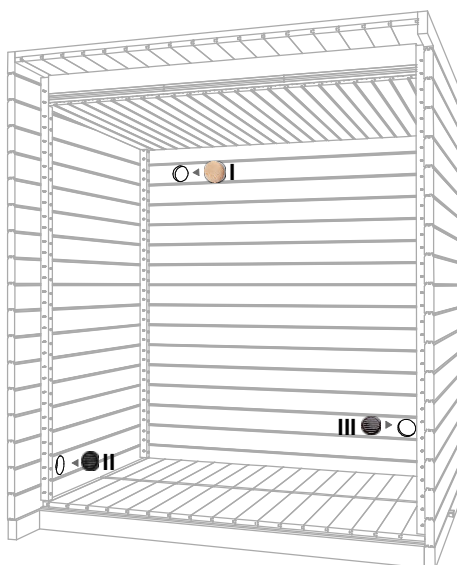

I - EXHAUST OPENING

Install the metal ventilation grid on the outside and the wooden valve on the inside.

The exhaust opening with the valve inside is located under the ceiling, and its purpose is to dry the steam room after using the sauna. The ventilation valve should be closed while using the sauna. Open the valve after using the sauna to expel excess moisture through the opening. For faster drying, leave the steam room door ajar after a sauna session.

The ventilation valve can also be opened between steam sessions if there are many people in the steam room at the same time and excessive humidity or a lack of air occurs.

II - INLET

Install a metal ventilation grid inside and outside.

III - OUTLET

Install a metal ventilation grid inside and outside.

Scheme 6.2

STEP 7 - Outer lining and moldings

Marking	Detail	Image	Note	Length	Pcs.
DI-1	15x55 Distance Board for Outer Lining			2250	2
STP-2	14x121 Outer Lining Board			250	21+1
L-1	18x95 Corner Molding		<i>Cut to length!</i>	2400	3
EXTRA	18x95 Corner Molding			2400	1
L-2	18x95 Roof/ Corner Molding		<i>Cut to length!</i>	2300	8
UL-1	18x95 Door Molding			1925	2
UL-2	18x95 Door Molding			1600	1
UL-3	18x95 Door Molding			1360	1
UL-4	15x55 Door Molding			1830	1

Marking	Detail	Image	Note	Length	Pcs.
	Moisture safety tape		for all corners	10 m	1
	Screw 3.5x40 Black		for distance boards and moldings		175
	Lost- head nail 40 mm		for outer lining boards		45
	Teknos Aqua Primer - Black				1

7.1 Tape all corners of the sauna with moisture safety tape before installing exterior moldings to prevent moisture and rainwater from entering the sauna (Scheme 7.1).

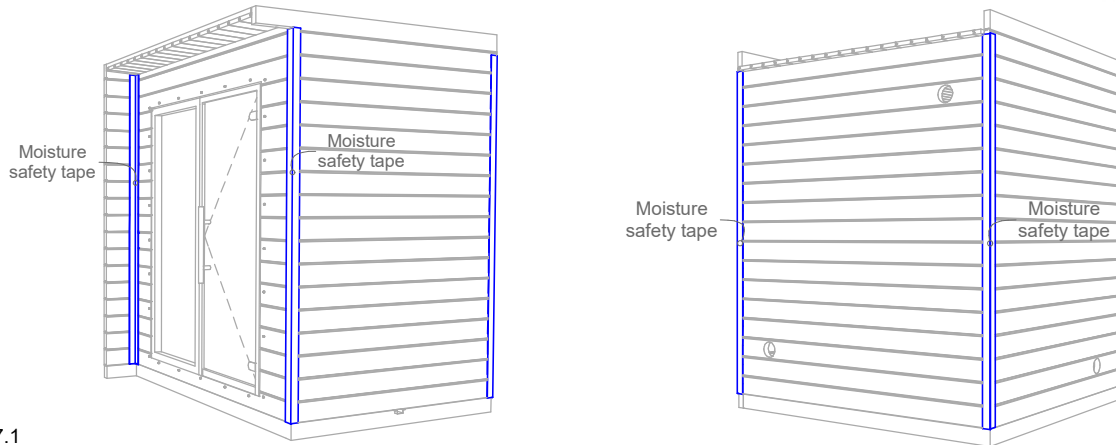

Scheme 7.1

7.2 Measure the height of the protruding part of the side wall and cut the DI-1 distance boards to the correct length if necessary. Attach the distance boards to the walls using 3x40 screws.

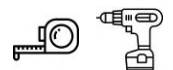

7.3 Install the STP-2 outer lining boards on top of the DI-1 distance boards, starting from the bottom. Cut the last lining board to the correct width. Use 40 mm lost-head nails to fasten the lining boards (2 nails per board). See Scheme 7.2.

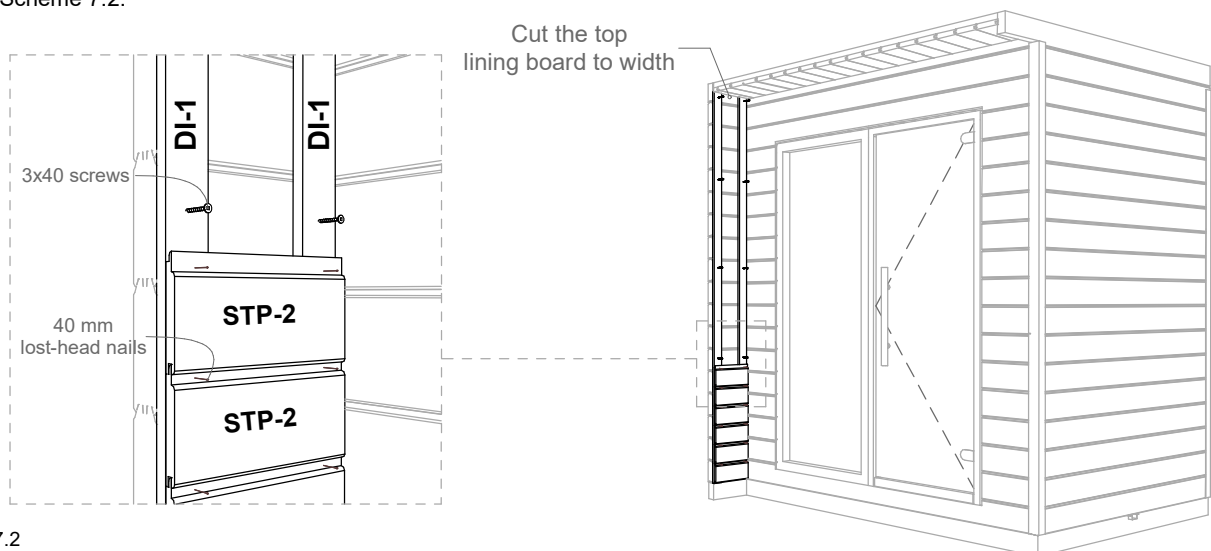
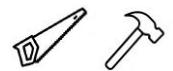

Scheme 7.2

STEP 7 - Outer lining and moldings

7.4 First, fix the L-3 roof moldings to the side walls. The moldings must be installed flush with the upper edges of the side walls. Cut the moldings to length and fasten using 3x40 black screws.



7.5 Next, measure and cut to length the L-3 roof molding at the front and fasten it to the roof block and side walls.



7.6 Make corner cutouts in L-1 corner moldings, as marked in Scheme 7.3. Cut to length and use 3x40 black screws to fasten all the corner moldings.

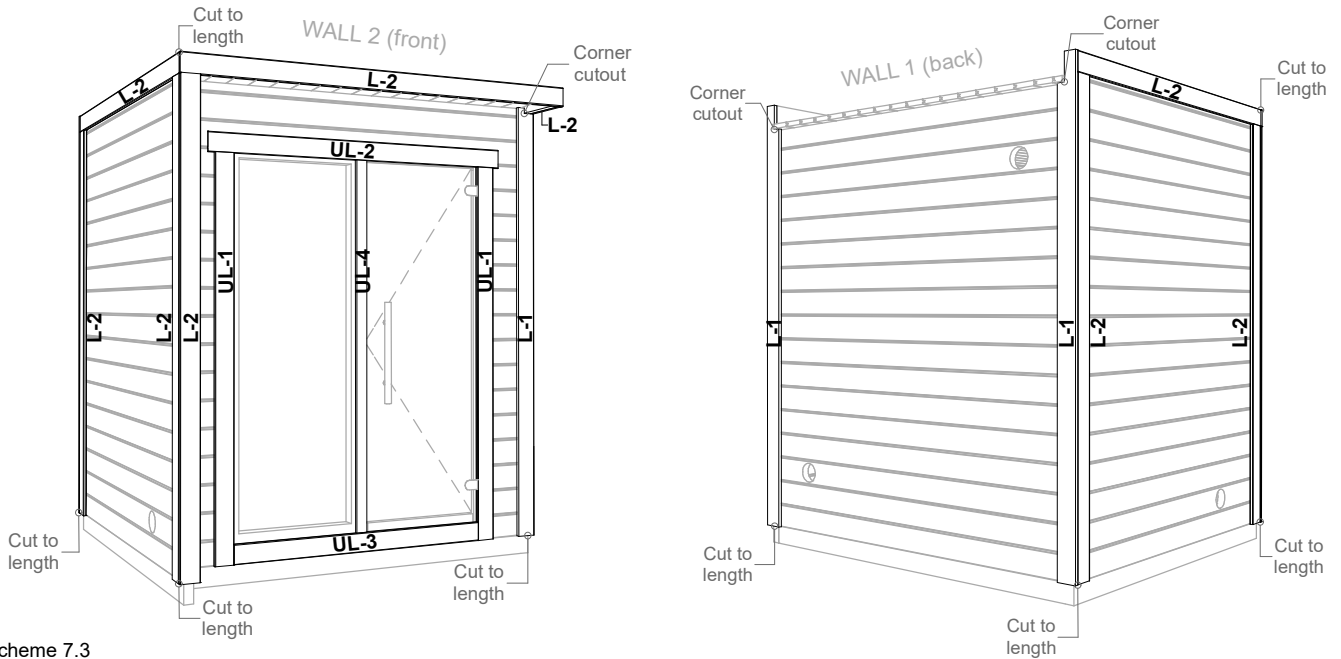

Scheme 7.3

7.7 Install the moldings around the door and window using 3x40 black screws. For the correct overlay, see Scheme 7.4.

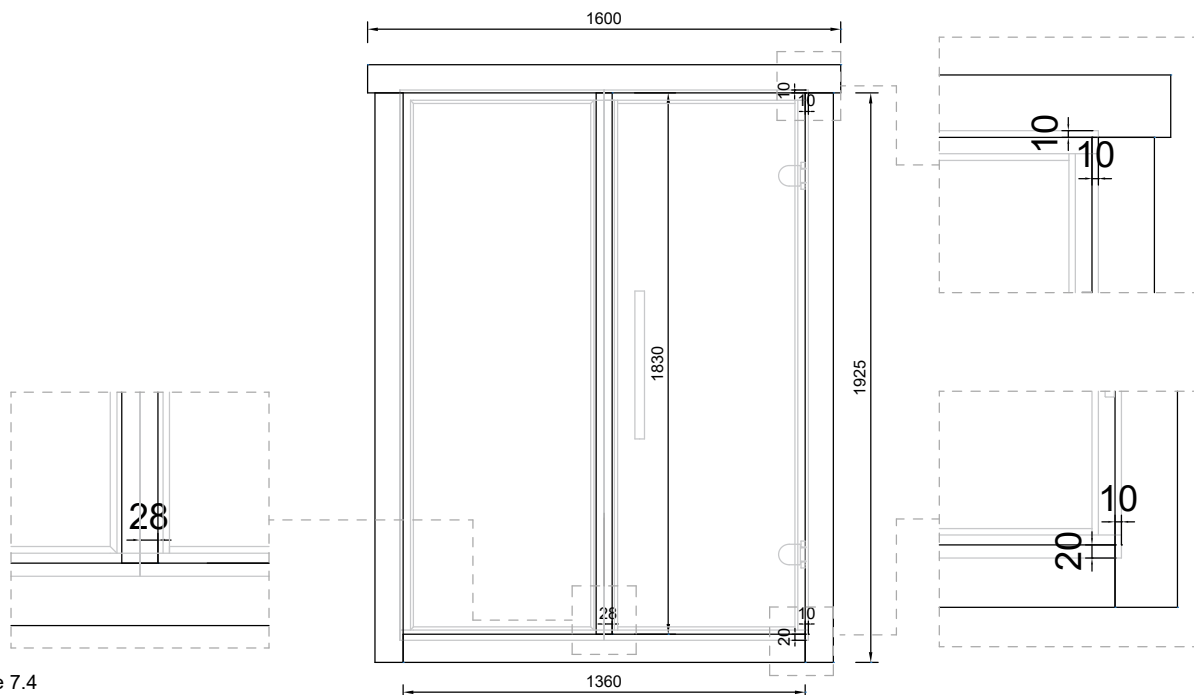

Scheme 7.4

7.8 Paint over all cut ends of the moldings with black Teknos Aqua Primer. Scan the QR code for more detailed product information.



STEP 8 - Sauna benches

Marking	Detail	Image	Note	Length	Pcs.
	Bench Module 600 mm		<i>Top bench</i>	1913	1
	Bench Module 400 mm		<i>Bottom bench</i>	1913	1
	Bench Skirt			1913	1
	Bench Horizontal Support Set 45x45				1

Marking	Detail	Image	Note	Length	Pcs.
	Screw 4.5x70		for all supports		30

- 8.1 Measure the distance and fix the upper and lower bench supports to the walls according to Scheme 8.1. Use 4.5x70 screws for fixing. It is recommended to additionally use glue (not included) for fixing the sauna bench supports to the wall.

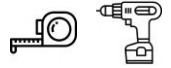

View from the front:

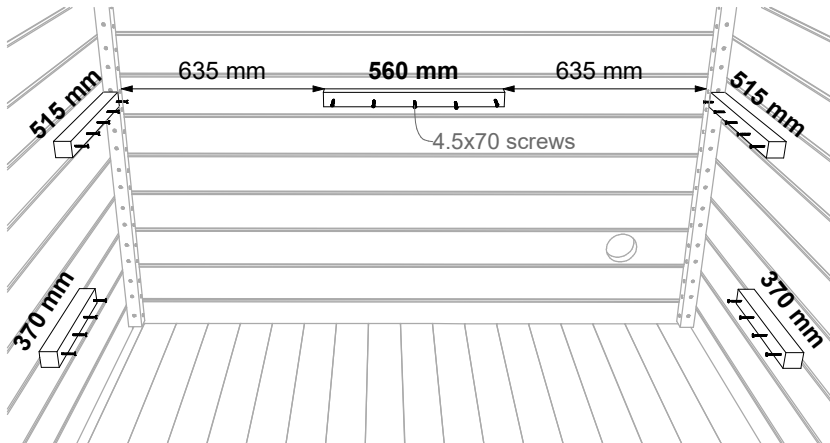

View from the side:

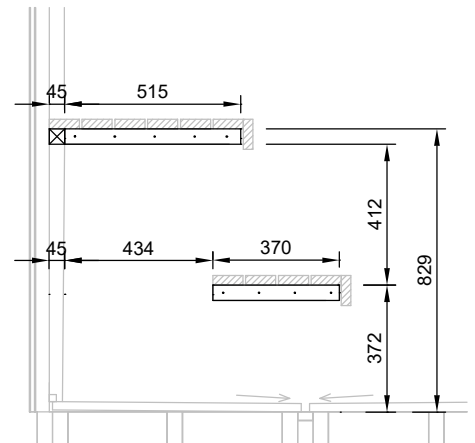

Scheme 8.1

- 8.2 Lift and place the bottom benches on top of the supports. If LED lighting under the sauna benches has been ordered additionally (not included in the standard set), install the LED strips under the benches before placing them on top of the supports. More detailed instructions are included with the lighting details.
- 8.3 Set the bench skirt in place. Leave a 8 mm gap between the skirt and the lower bench. Fix the skirt side frames to the side walls and the middle frame to the bottom bench, using 4x70 screws. See Scheme 8.2

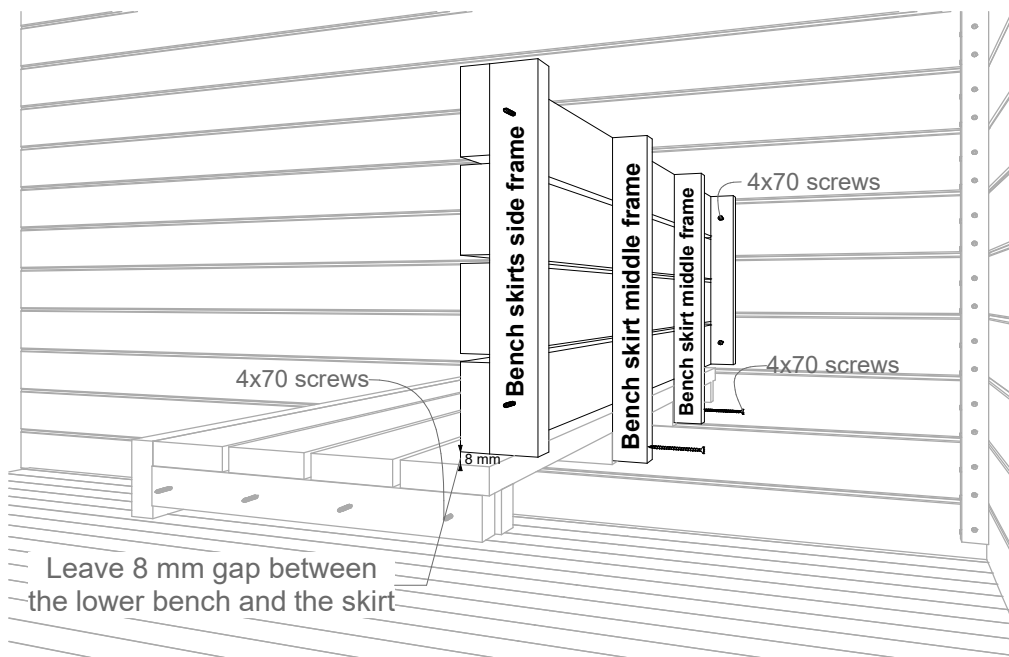

Scheme 8.2

STEP 8 - Sauna benches

8.4 Lift and place the top benches on top of the supports. Leave ~4 mm gap on the sides. See Scheme 8.3.



8.5 Fix all the benches to the horizontal supports through the bottom frame using 4.5x70 screws.
Do not fully tighten the screws.

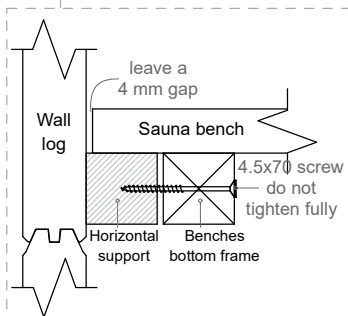
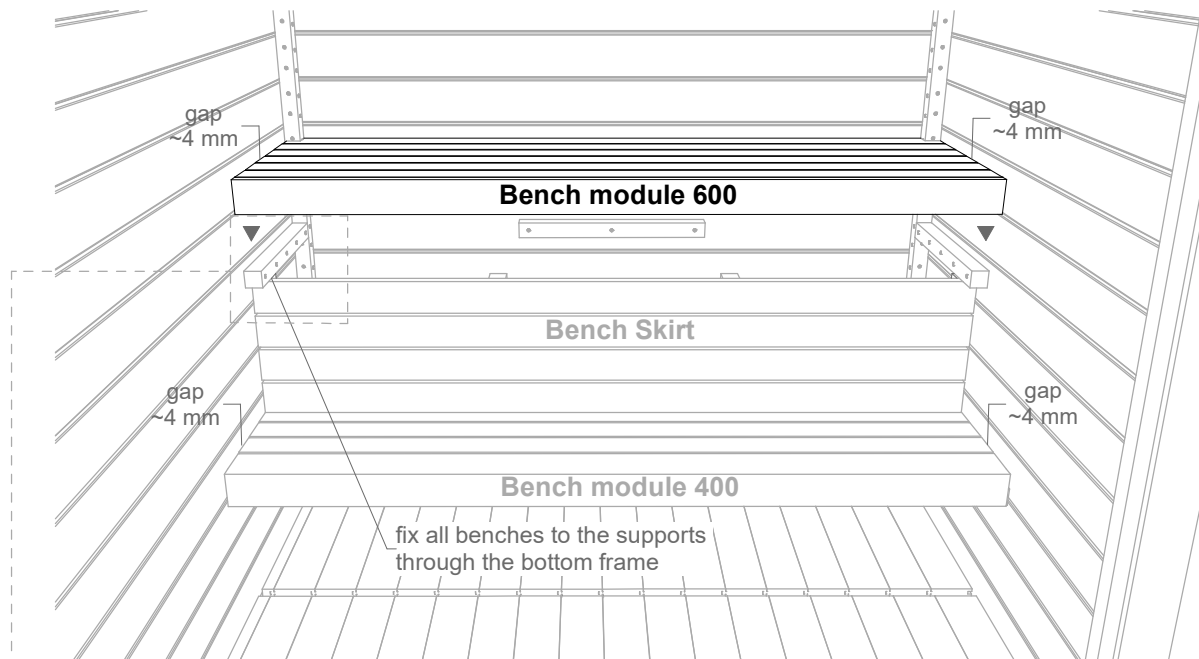

Scheme 8.3

STEP 9 - Interior moldings

Marking	Detail	Image	Note	Length	Pcs.
DI-0	50X50 Corner Post Molding		<i>Cut to length!</i>	2100	4+1
DI-00	21x21 Ceiling and Floor Molding		<i>Cut to length!</i>	~2100	8

Marking	Detail	Image	Note	Length	Pcs.
	40 mm lost-head nail		for all interior moldings		120

9.1 Measure and cut to length all DI-0 corner post moldings with a handsaw.

Install DI-0 corner molding on top of the corner posts, under and above the sauna bench, like shown in Scheme 9.1. Fasten the moldings with 40 mm lost-head nails, using a nail gun or a hammer.

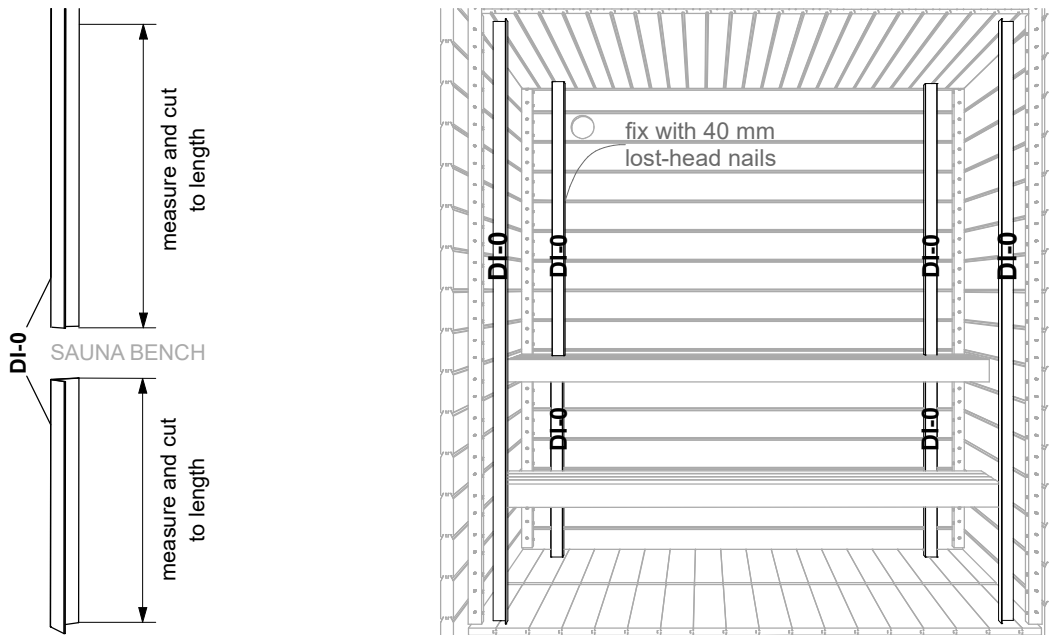



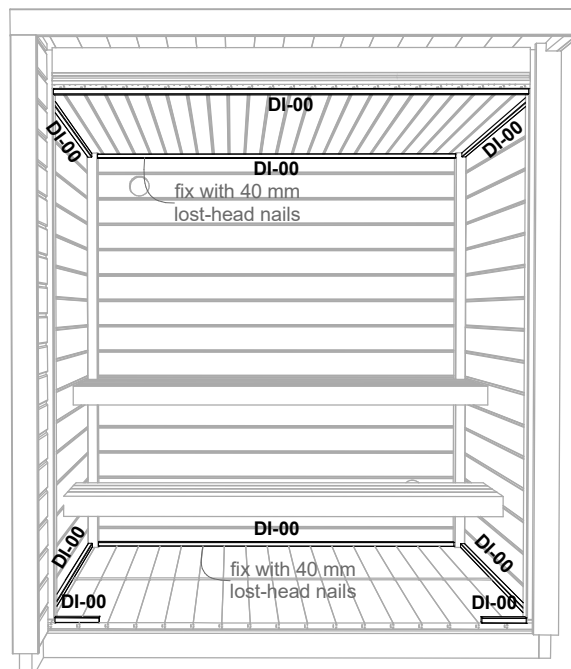

Scheme 9.1

9.2 Measure and cut to length all DI-00 ceiling and floor moldings and fasten them with 40 mm lost-head nails. Use a nailgun or a hammer (Scheme 9.2).



Scheme 9.2

STEP 10 - Roof covering and moldings

Marking	Detail	Image	Note	Length	Pcs.
	EPDM Rubber Roof Cover 2x3.05 m				1
	EPDM Glue		2.5 l		1
	EPDM Quickprime		125 ml		1
	Paint roller + Handle				1
	Metal roofing sheet		for back wall <i>Cut to length!</i>	2000 mm	1
	Metal roofing sheet		for front and side walls. <i>Cut to length!</i>	2100 mm	3

Marking	Detail	Image	Note	Length	Pcs.
	Black Wronic Screw 4.2x25		for back wall metal roofing sheet		10
	Black Roofing Screw 4.2x25		for side walls metal roofing sheets		35
	Splice Tape		for back wall metal roofing sheet	1,93 m	1
	Remmers HK Stain - Pine		for finishing the outer surface of wall logs		1

- 10.1 Clean the roof surface from dirt, dust, ice, snow, water, etc.
- 10.2 Cut the back wall metal profile to length with sheet metal scissors. Leave a 1 mm gap on both sides. Attach the back profile to the roof boards on the back wall using 4.2x25 black Wronic screws.
- 10.3 Check the EPDM roof cover for defects before installing. Put the rubber roof cover in position and check for the correct overhang (Image 1).
- 10.4 Fold and roll the rubber roof cover, and start applying the glue to the roof boards and the rubber surface one half at a time. (Image 2). Apply glue in a well-ventilated area. Use gloves, safety goggles, and a respirator.
- 10.5 **Important!** Wait until the glue is "touch dry" (approximately 15 minutes or longer) before folding the rubber in place. Waiting for the glue to dry is necessary to prevent the rubber from bubbling after it is set in place.
- 10.6 Apply Quickprime + glue on top of the back metal profile and rubber. Then apply the double-sided splice tape on top of the metal profile (Scheme 10.1).
- 10.7 Remove the top side of the splice tape and apply the glued rubber on top of the tape. Fold the rubber roof cover in place. Avoid air bubbles and wrinkles on the surface (Image 3).
- 10.8 Smooth the roof cover with a broom or a brush and cut off the excess rubber (Image 4).



Image 1



Image 2

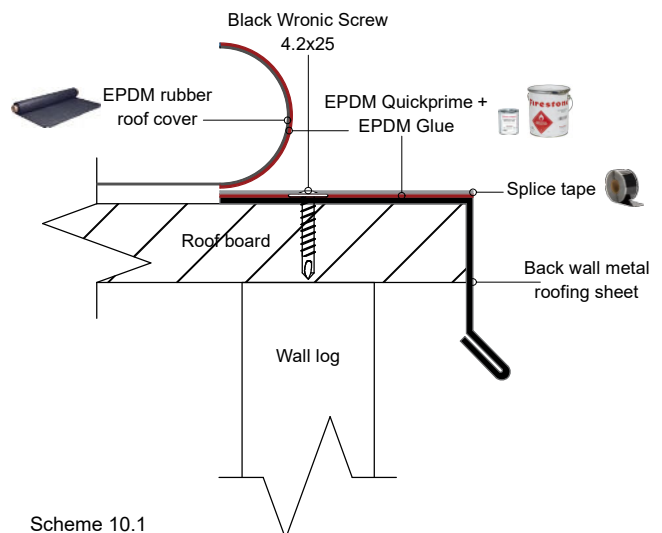

Image 3



Image 4

Back wall metal roofing sheet:



STEP 10 - Roof covering and moldings

- 10.9 Cut 58 mm off the side metal profiles at one end, like shown in Scheme 10.2. Use sheet metal scissors, pliers and protective gloves to prepare metal roofing sheets for installation.
- 10.10 Cut 68 mm off the front metal profile at both ends, like shown on Scheme 10.2.
- 10.11 Fit the front metal roofing sheet on top of the side metal roofing sheets with ends overlapping, like shown in Scheme 10.4.

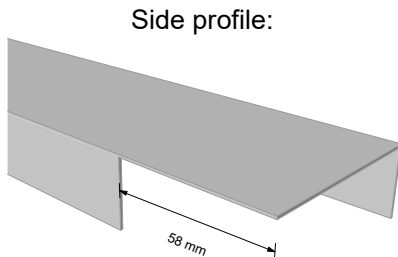

Scheme 10.2

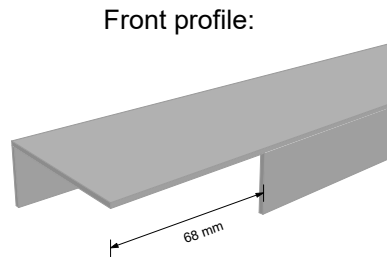

Scheme 10.3

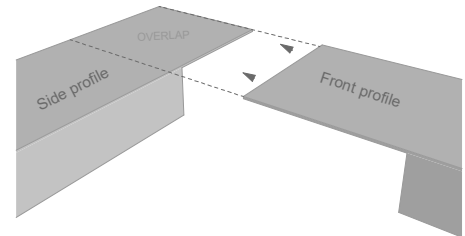

Scheme 10.4

- 10.12 Use 4.2x25 black roofing screws to fix the profiles to walls at the sides and the roof block at the front (Schemes 10.5 and 10.6).

Front wall metal roofing sheet:

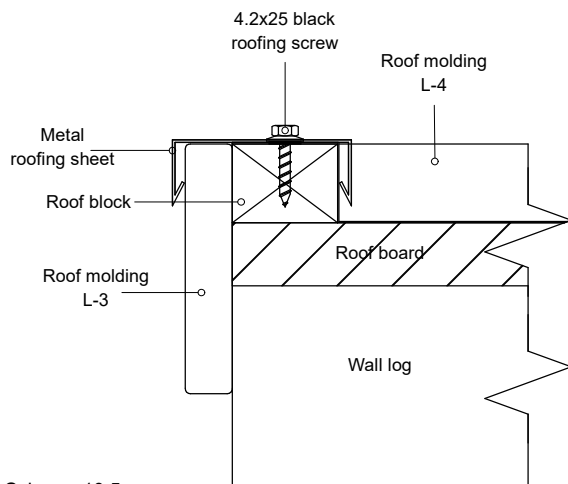

Scheme 10.5

Side wall metal roofing sheet:

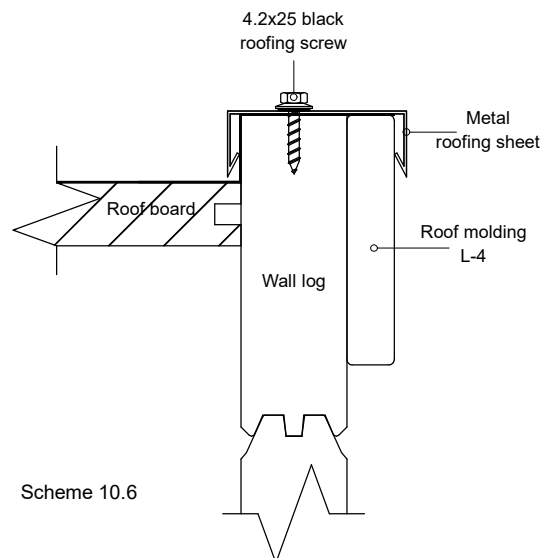

Scheme 10.6

- 10.13 At the back wall, cut and fold the excess metal roofing sheet 90 degrees downward (Scheme 10.7). Fix with 4.2x25 roofing screws (Image 6).

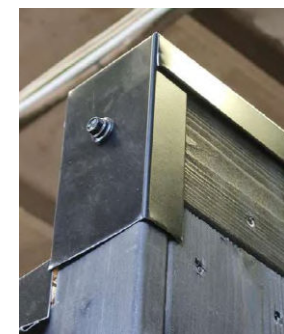
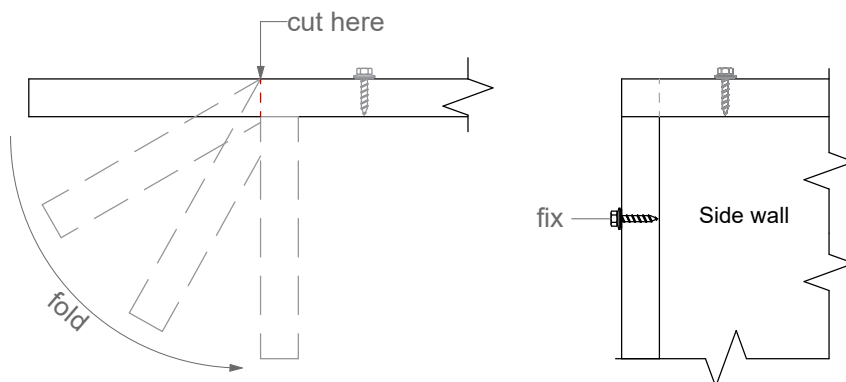

Image 6

Scheme 10.7

- 10.14 Paint the wall logs over with Remmers Lazur to protect the wood against weather conditions. Scan the QR code for more detailed product information.



Congratulations on a job well done!

You have successfully completed the installation and can soon start enjoying your new sauna.

Before the first use, please read the maintenance and warranty guide and perform the necessary actions.

Maintenance

The interior surfaces of the sauna, the window frames of the steam and anteroom, and the frames of interior doors must be treated with a special substance before initial use, to protect the wood from humidity and dirt and extend the service life of the sauna.

Before initial use of the sauna and once a year after that, the door, doorframe, threshold, and window frames, as well as the floors of the anteroom should be treated with Teknos Helo Aqua 40 lacquer.

The benches and backrests must be treated with a protective oil, to extend their service life. This procedure should be repeated once or twice a year in the future.

Suitable products for this purpose:

- TEKNOS Satu Saunasuojaor
- Tikkurila Supi Saunasuoja May

The exterior surfaces of the sauna need to be given the first protective coating right after installation. The second coating should be applied approximately two months after installing the sauna, to maintain its appearance. Use Remmers HK-Lasur for this purpose.

The substance is available for purchase at Saunasell OÜ or from the website:

<https://trendwood.ee/tooted/viimistlus/remmers/5>.

The seller is not liable for any damage caused to the sauna due to insufficient maintenance or no maintenance at all.

Warranty

The products have a 24-month warranty period covering material and production defects, taking effect from the delivery of the sauna to the client.

The warranty is valid, if the user has reviewed the user manuals and abides by it.

The warranty does not cover characteristics of wood, such as discoloration or cracks caused by alternating or excess humidity, etc.

The warranty does not cover normal wear and tear of the product caused by its use. Any damage caused by incorrect installation or use is not compensated.

The warranty does not cover damage caused by thunder or other weather phenomena.

The warranty does not cover damage caused by incorrect installation by the client.

The warranty expires when attempts are made to independently change or fix the product or if it is not used for its intended purpose.

The warranty is void if the product is stored in an incorrect position or in the wrong conditions.

The warranty is valid if the buyer informs the seller of the defect within a reasonable time (7 days).