

# **HALDEN S 40 INSTALLATION DRAWINGS**



## HOUSE: HALDEN S 40

POS.	DESCRIPTION	NOTE	PCS.	PROFILE	LENGTH
AR5	IMPREGNATED FLOOR FRAMING		1	45x95	2875
AR4	IMPREGNATED FLOOR FRAMING	CUTOUT	1	45x95	2875
AR3	IMPREGNATED FLOOR FRAMING		9	45x95	1980
AR1	IMPREGNATED FLOOR FRAMING	CUTOUT	1	45x95	1980
AR2	IMPREGNATED FLOOR FRAMING		1	45x70	1980
PL-1	FLOOR BOARD		18+2	24x112	1965
KL-1	ROOF BOARD		31+3	24x112	2668
SL-1	CEILING BOARD		18+2	14x111	2013
TL-1	IMPREGNATED TERRACE BOARD		17+2	28x120	800
TL-2	IMPREGNATED TERRACE BOARD		1	28x120	2070
PP-1	FLOOR/CEILING/ROOF MOULDING		11+1	15x55	2100
DL-1	SPACER		4	15x55	1996
R-1	BATTEN	BEVELLED	2	45x45	1996
RLT-1	ROOF EDGE SUPPORT		2	45x45	3406
RL-1	ROOF EDGE BOARD		2	18x95	2800
RL-2	ROOF EDGE BOARD		2+1	18x95	3500
APL55-1	MOULDINGS FOR 845+845x1792 WINDOW	1 SET	2	15x55	1752
APL95-1			2	18x95	1650
APL95-2			2	18x95	1900
APL95-3			4	18x95	1877
UPL95-1	MOULDINGS FOR 690x1860 DOOR	1 SET	1	18x95	920
UPL95-2			2	18x95	1890
UPL-1	EXTRA MOULDING		2	18x95	2400

**HOUSE: HALDEN S 40**

	DESCRIPTION	NOTE	PCS.
DOOR/WINDOW	EXTERIOR DOOR WITH WOODEN FRAME 88x690x1860		1
	WINDOW 45x845x1792		2
	DOOR HANDLE SET FOR EXTERIOR DOOR	WOODEN	1

	DESCRIPTION	NOTE	PCS.
COMPONENTS	BENCH MODULE 600x1992		1
	BENCH MODULE 400x1992		1
	BENCH SUPPORTS SET 45x45 (560-3PCS, 500-1PC, 452-2PCS, 375-2PCS)		1
	ADDITIONAL VERTICAL BENCH SUPPORT 45x45x1000	ADJUSTABLE	1
	OUTDOOR BENCH 563x750		1
	GRID WALL 650x1711		1
	3MM SLOPE BOARD	1996MM	1
	6MM SLOPE BOARD	1996MM	1
	9MM SLOPE BOARD	1996MM	1
	12MM SLOPE BOARD	1996MM	1
	INSULATION SHEET 30x600x1200		6
	ALUMINUM TAPE		20M
	WOODEN VENTILATION LOUVER D100		2
	METAL VENTILATION GRID D100		2
	DRAINAGE 2000+	OPENS RIGHT	1

**HOUSE: HALDEN S 40**

	DESCRIPTION	PCS.	
FASTENERS	3.5x50 SCREW FOR FLOOR BOARDS	200	
	3x40 STAINLESS SCREW FOR DOOR/WINDOW MOULDINGS	100	
	4.2x55 STAINLESS SCREW FOR TERRACE AND ROOF EDGE BOARDS	200	
	5x40 SCREW FOR ANGLE BRACKETS	50	
	4.5x60 SCREW FOR ROOF EDGE SUPPORT	40	
	4.5x70 SCREW FOR BENCH MODULES, BATTENS, GRID WALL AND DOOR FRAME	100	
	5x90 SCREW FOR FLOOR FRAMING AND CONNECTING WALL LOGS WITH FLOOR FRAMING	50	
	6x120 SCREW FOR WALL LOG INTERSECTIONS	200	
	6x180 SCREW FOR PURLINS, CONNECTING WALL LOGS WITH FLOOR FRAMING AND WALL LOGS	30	
	75MM NAIL FOR ROOF BOARDS	300	
	40MM LOST HEAD NAIL FOR CEILING BOARDS	250	
	ADJUSTABLE POST SUPPORT 60x60		1
	SLIDING BRACKET 35x35x130 FOR GRID WALL		2
	WASHER M5 FOR SLIDING BRACKET		2
ANGLE BRACKET 40x40x40 FOR WINDOWS		6	

# BASE PLAN

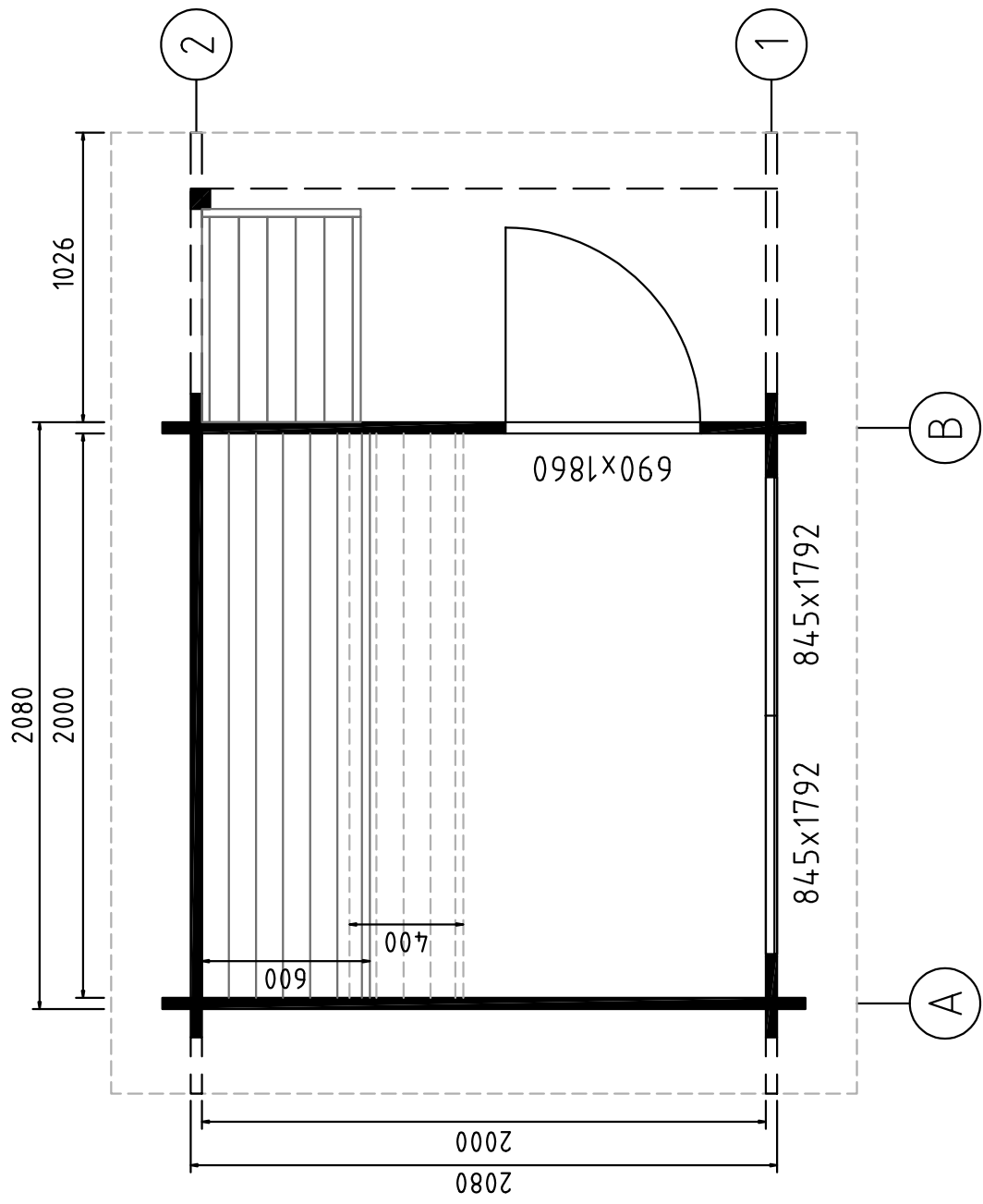

# FLOOR FRAMING 45x95

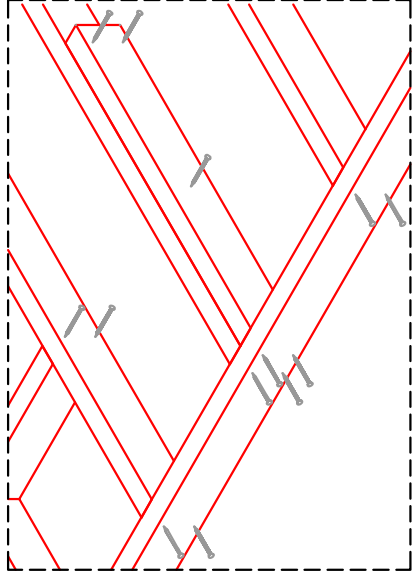
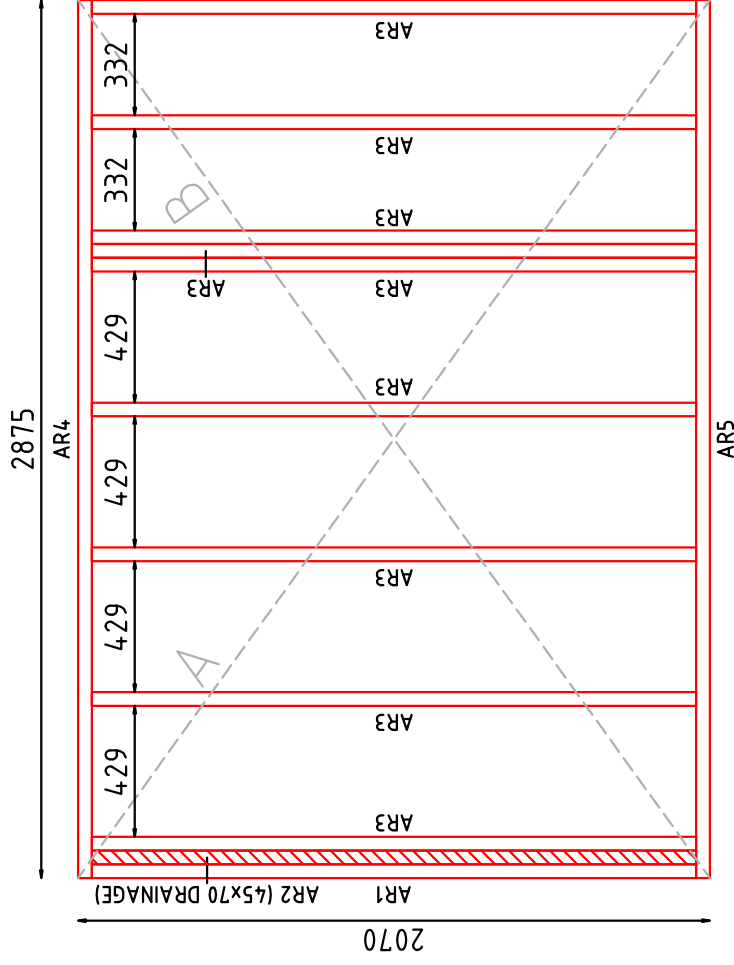

Use two 5x90 screws to fasten joist ends with crossing joists. Fix with parallel joists, when there is no crossing joists.

NB! Check diagonals, remember that  $A=B=3543$

# FASTENING WALL LOGS

Fasten first row to floor framing. Use 5x90 screws for half logs (fix those first) and 6x180 screws for full logs. It is recommended to predrill holes. If necessary use rubber hammer and hit block to secure logs tightly on top of each other.

Use 6x120 screws in each intersection. Try to alternate placement of drill holes so screws don't end up on top of each other. It is recommended to predrill the holes.

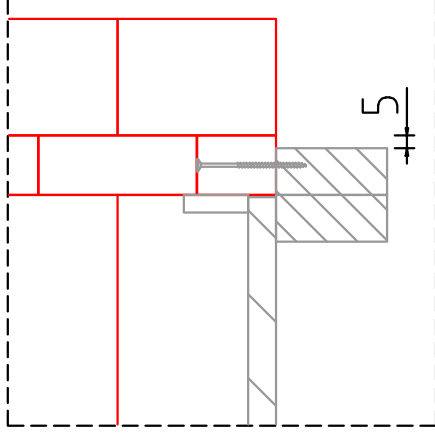
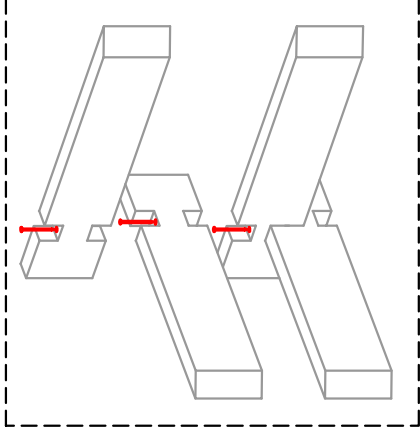
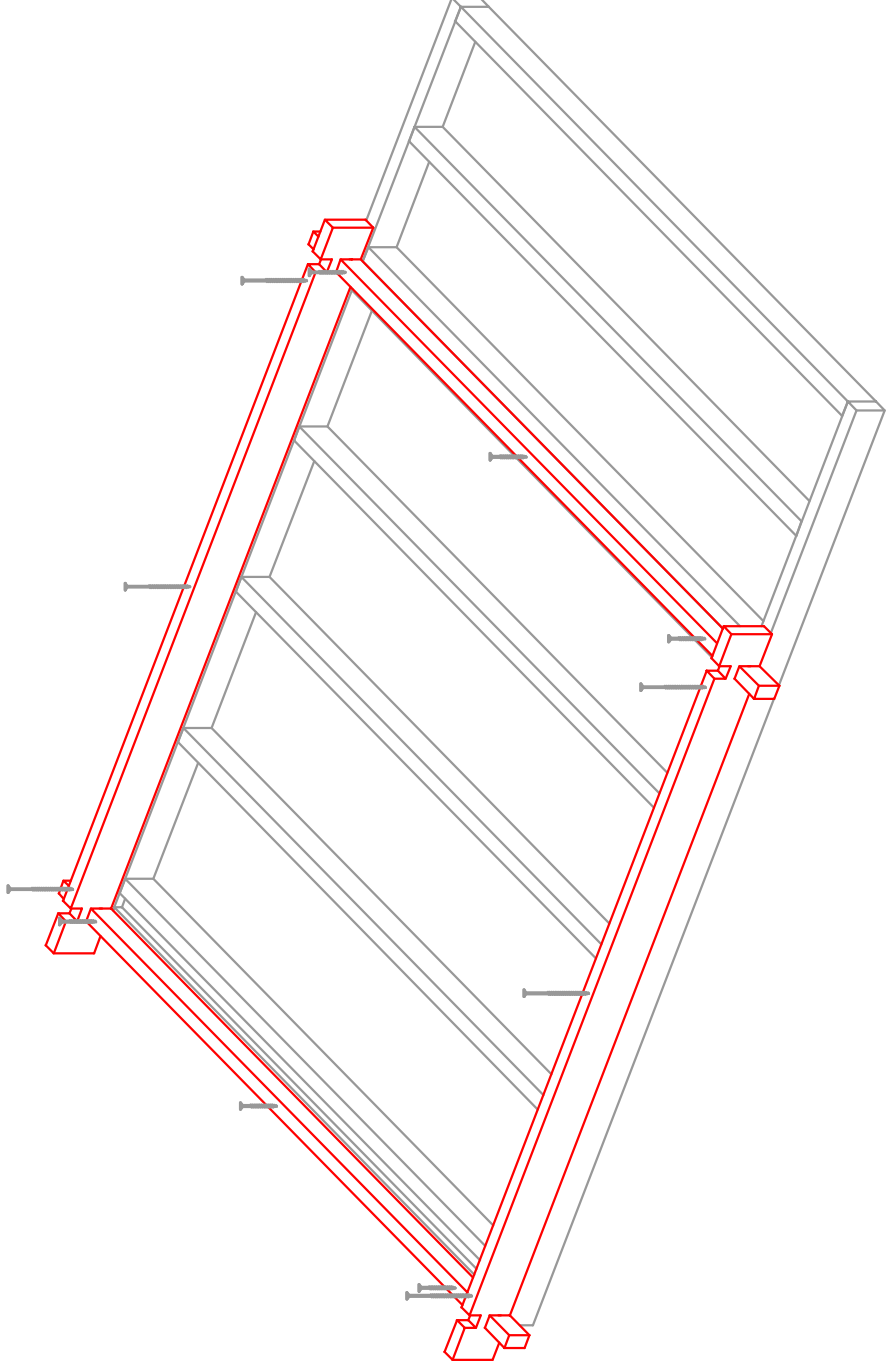

Framing should be 5mm inside from outer wall.





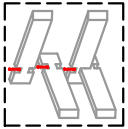

# WALL A

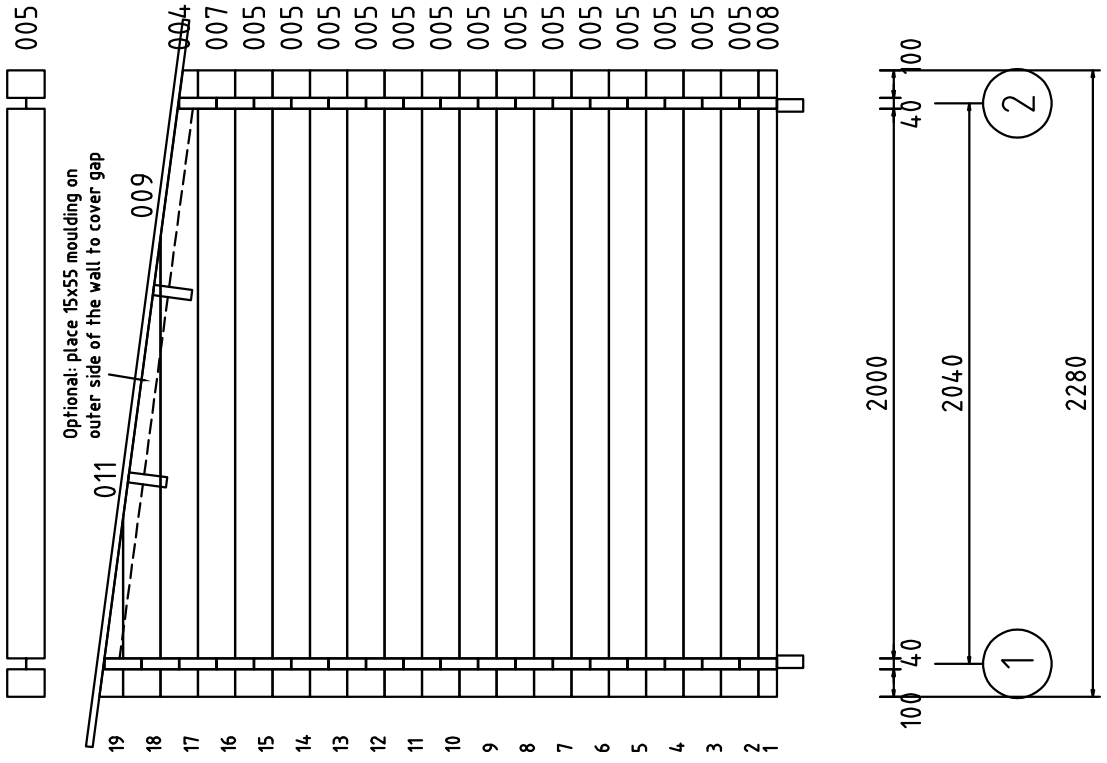

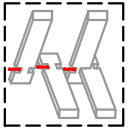

# WALL B

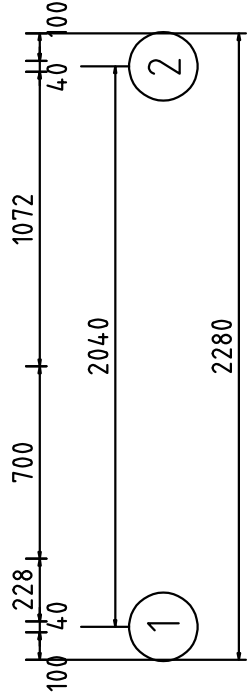
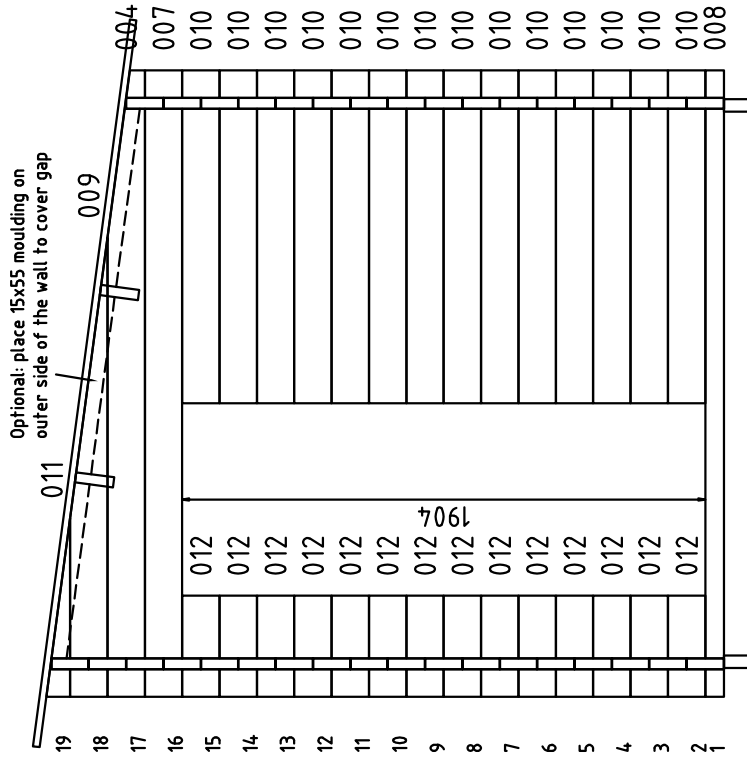

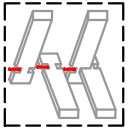

# WALL 1

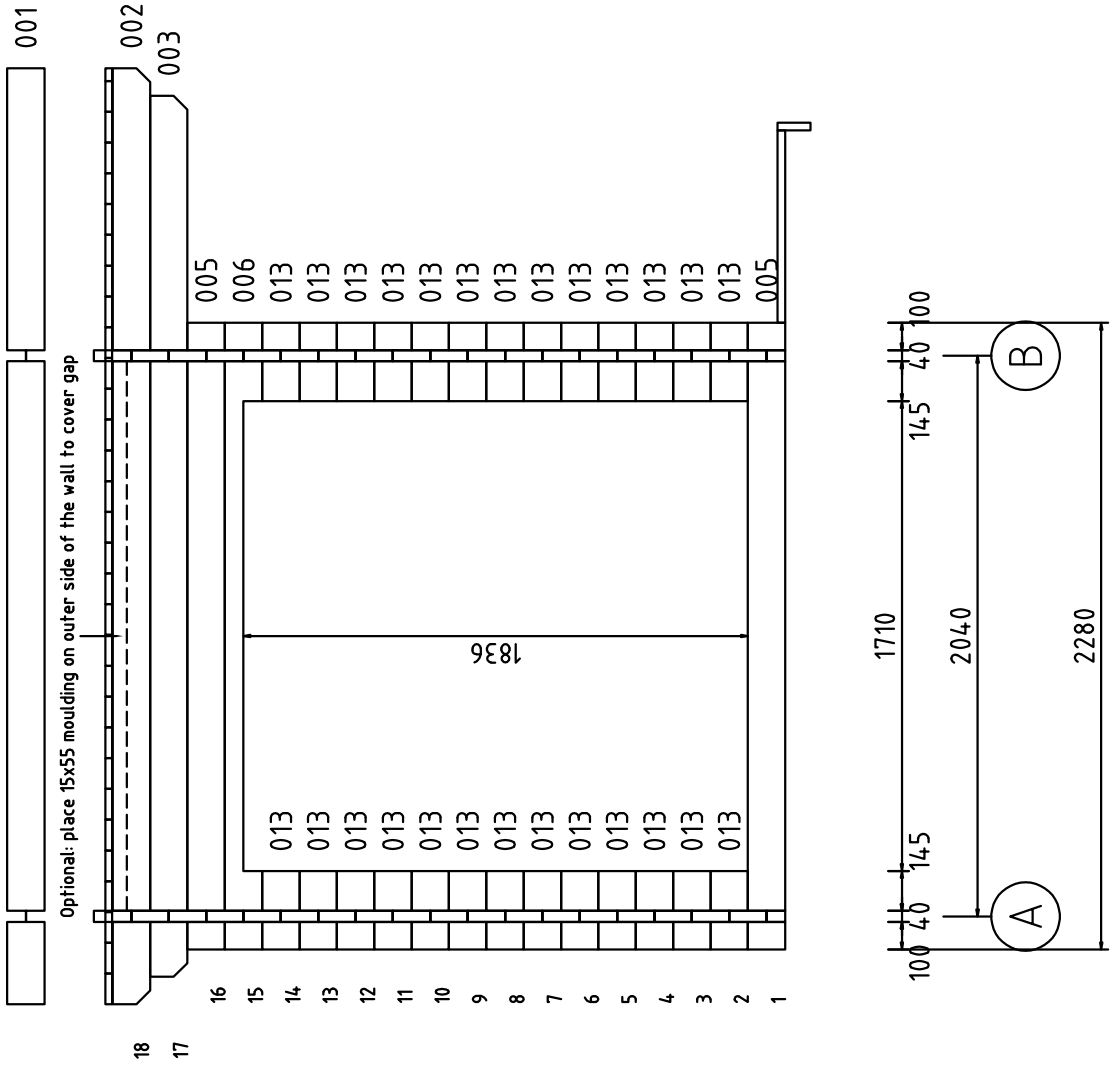

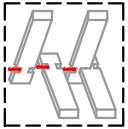

# WALL 2

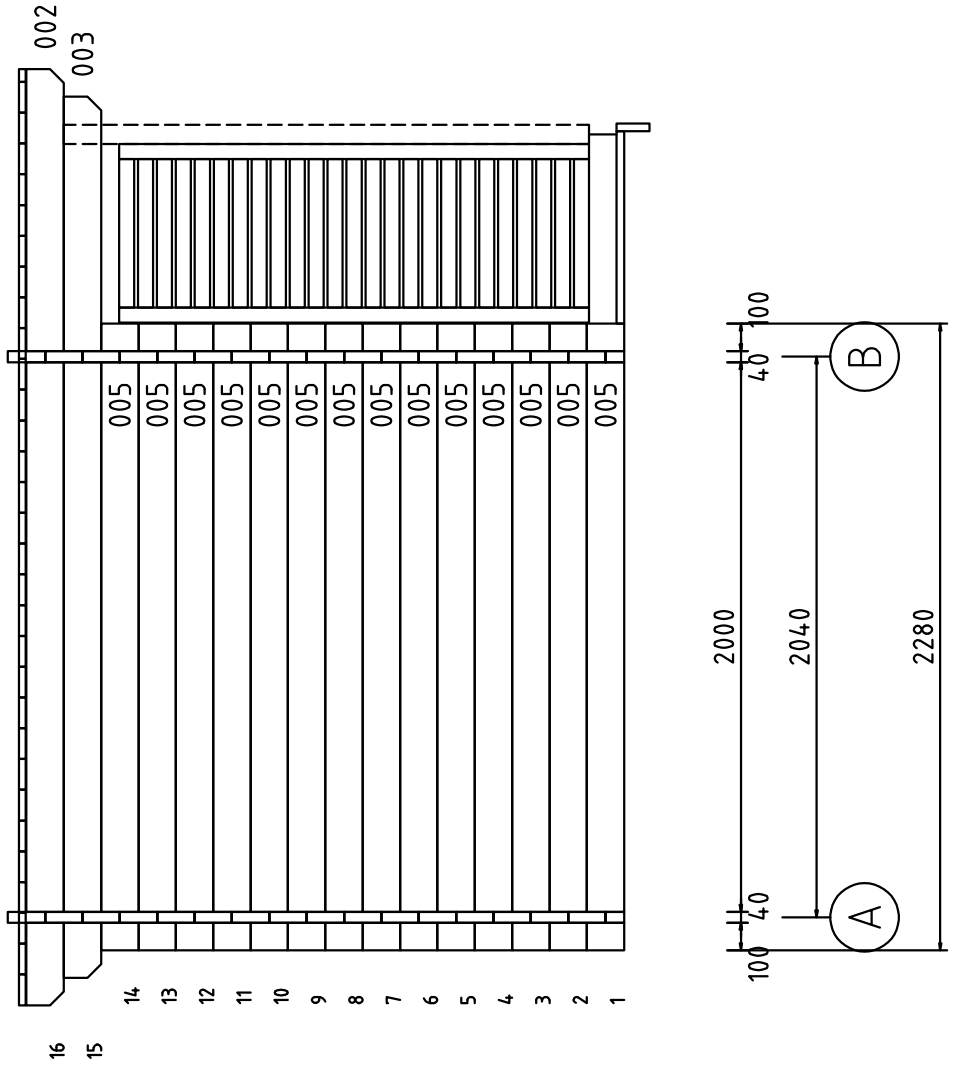

Add slope boards and drainage details before fixing floor boards.

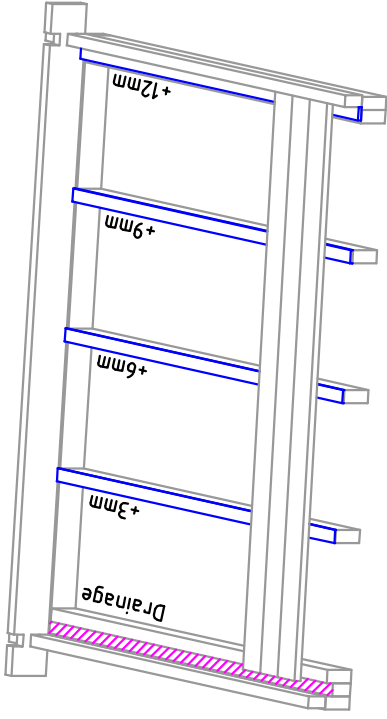

When placing drainage, fix closed end temporarily ~5mm higher than opened end to guarantee slope towards outer wall for water. After placing floor boards fix it permanently with floor mouldings.

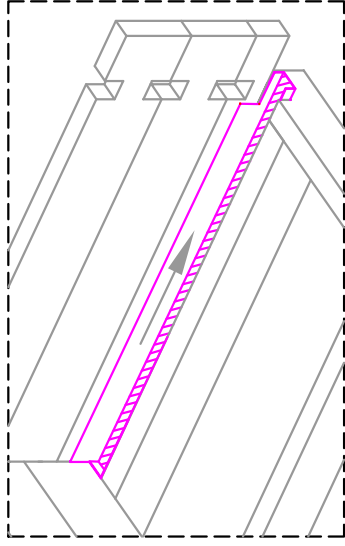

## FLOOR BOARDS

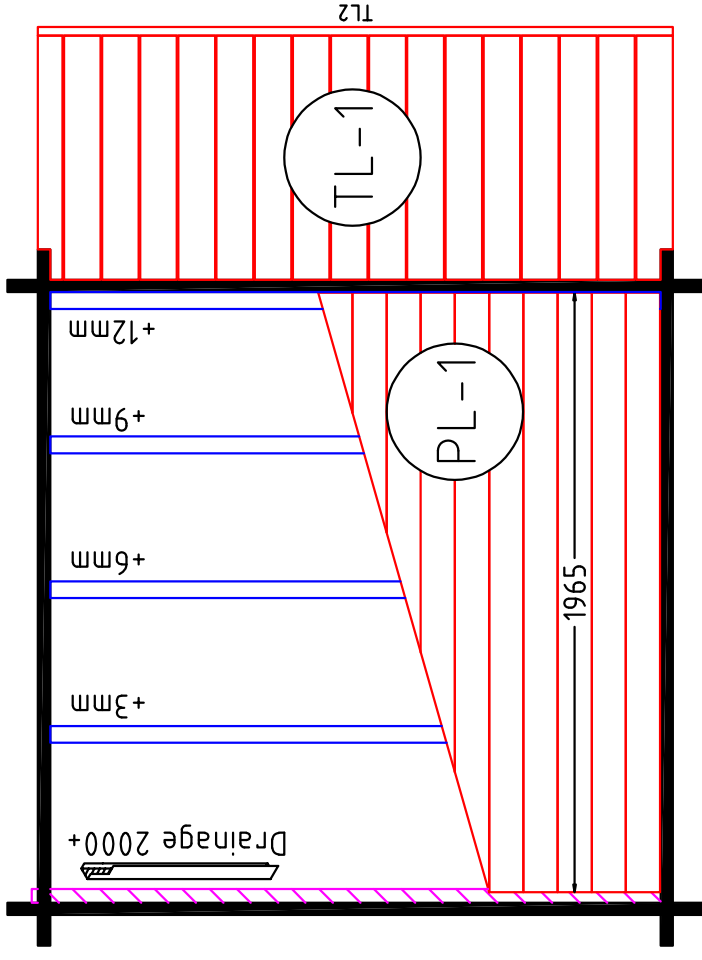

Fasten floor boards with screws from the tongue side of the board. First board should be placed ~5mm from wall and when cutting last board make sure there is 5mm gap as well. Leave ~2mm gap between floor board (cross cut sides) and walls. Lastly fix mouldings in place.

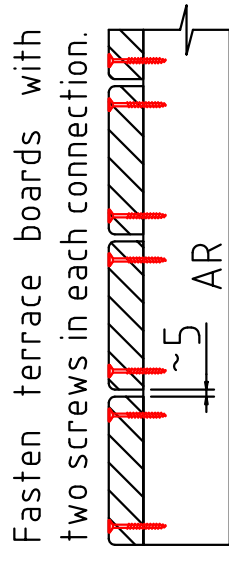
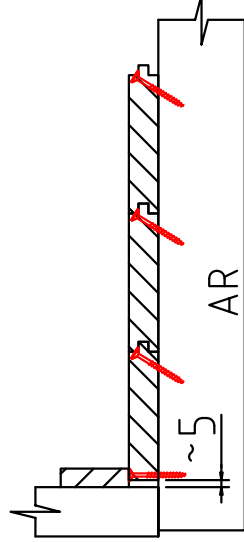

# ROOF BOARDS

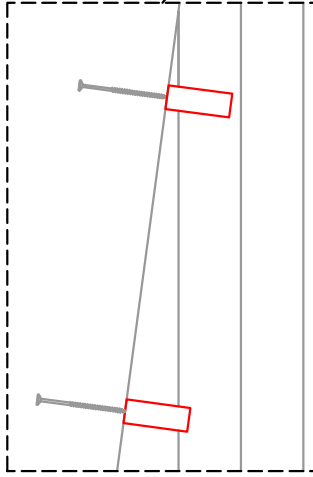

1. Fix purlins with 6x180 screws (pre-drill holes).

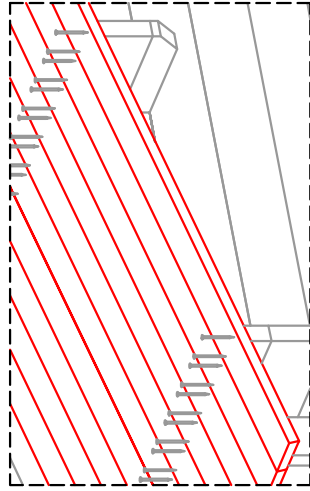

2. Fix roof boards with 75mm nails (2pcs for each connection).

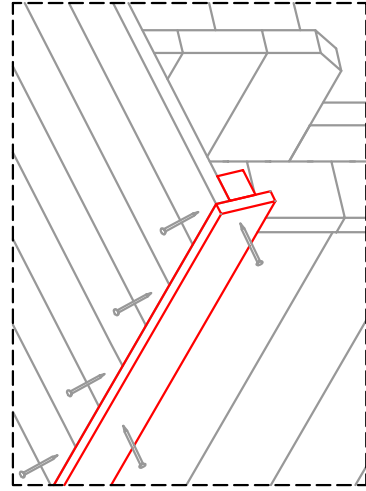
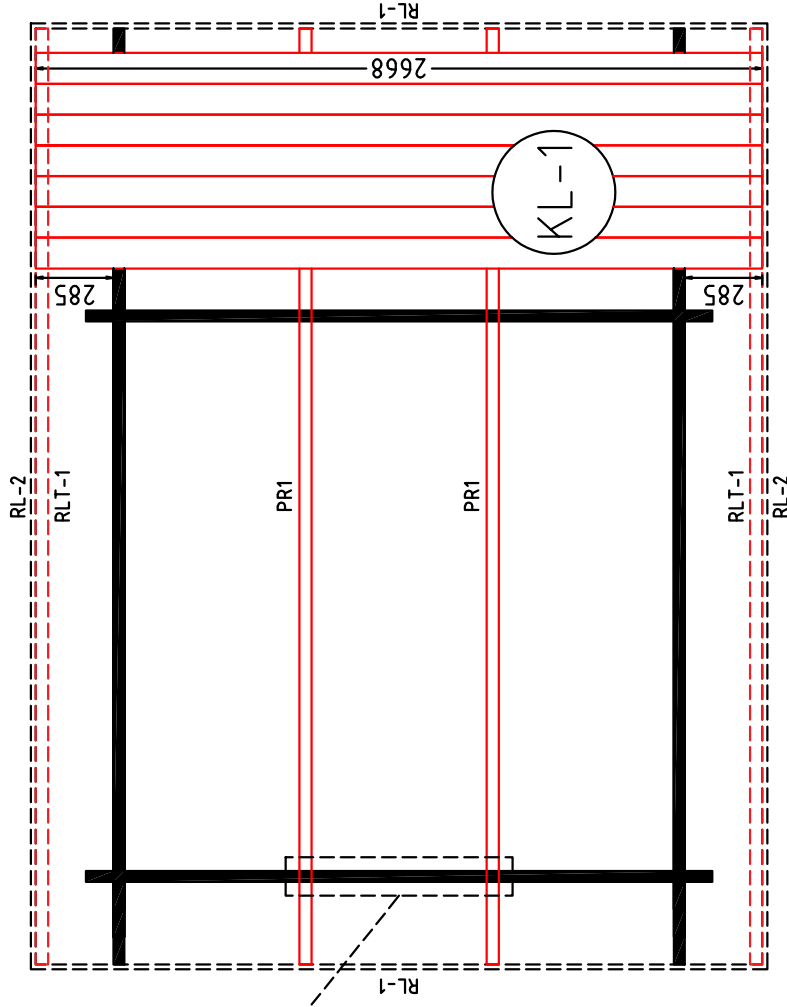

3. Fasten roof edge support and board. Use 4,5x60 screws (one for every other board ending) to fix edge support. For edge boards use 4,2x55 screws.

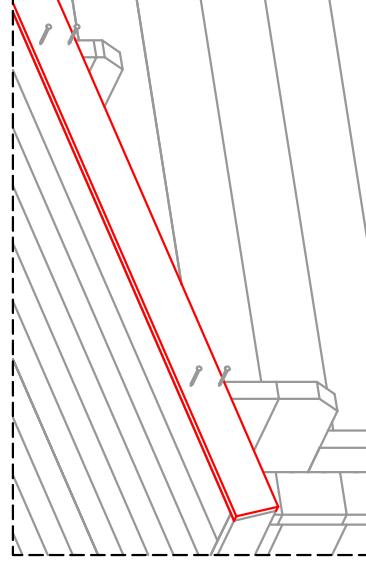

4. Cut gable edge boards to length and fix with 4,2x55 screws.

# FASTENING DOORS/WINDOWS

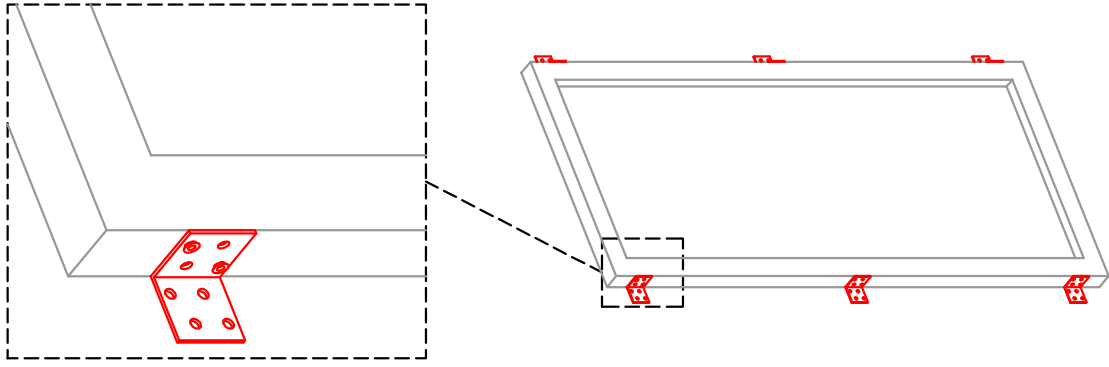

1. Fasten 40x40x40 angle brackets to window jambs (3pcs for each side) with two 5x40 screws. Make sure that brackets are 3mm inside from outer surface of the jamb, so there will be enough room for screw heads when mounting windows to walls and fixing mouldings.

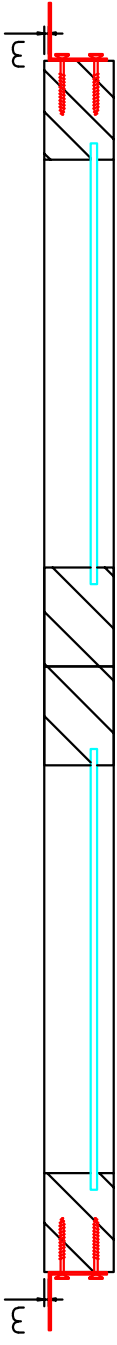

2. Lift window in place and fasten angle brackets to wall with 5x40 screws (2pcs for each bracket).

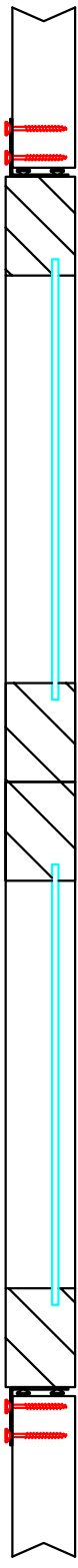

3. Fasten mouldings with 3x40 screws. Mouldings should cover about 20mm of frame.

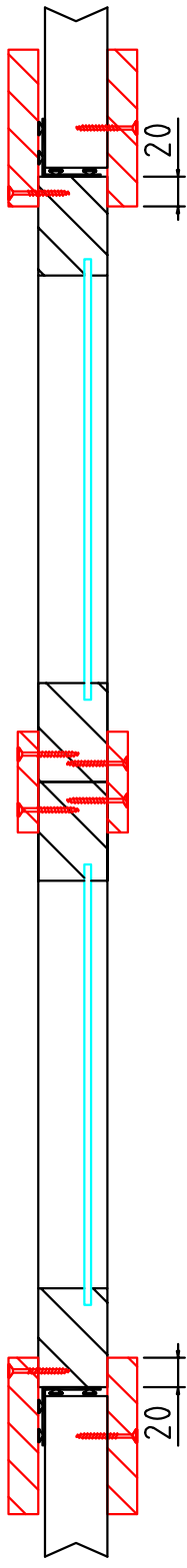

1. Lift door in place and fix it to wall by screwing 4,5x70 screws through wall to frame.

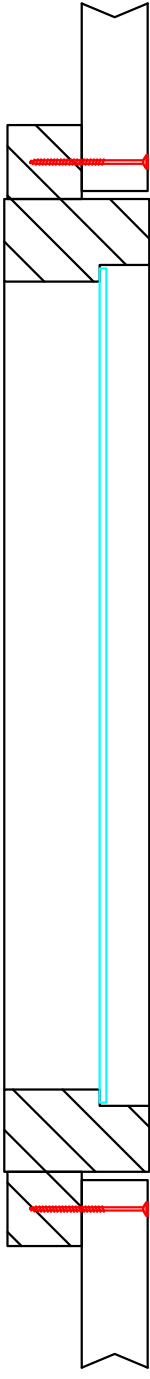

2. Fasten mouldings with 3x40 screws. Mouldings coverage is about 20mm on upper moulding and 10mm on sides. There are no mouldings on the side of the frame.

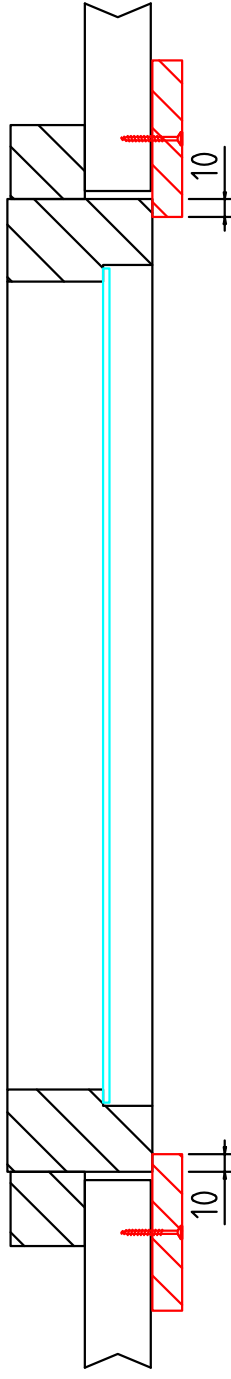

# DOOR/WINDOW MOULDINGS

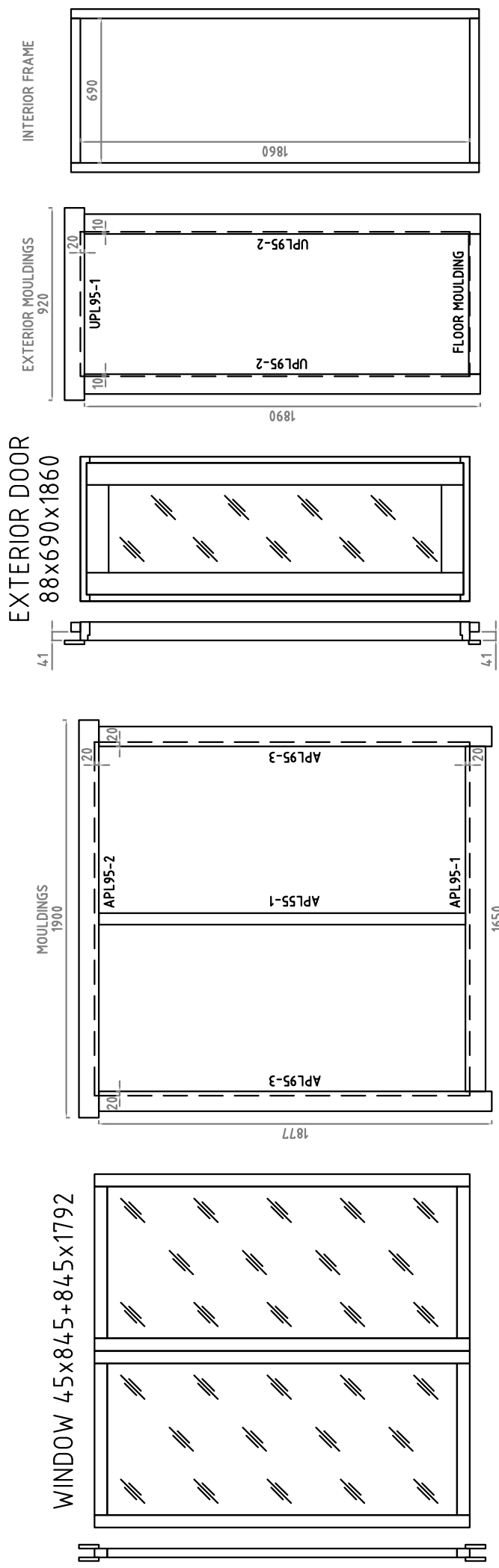



1. Fasten battens (R-1) to side walls so that they are in line with purlins. Use 4,5x70 screws.

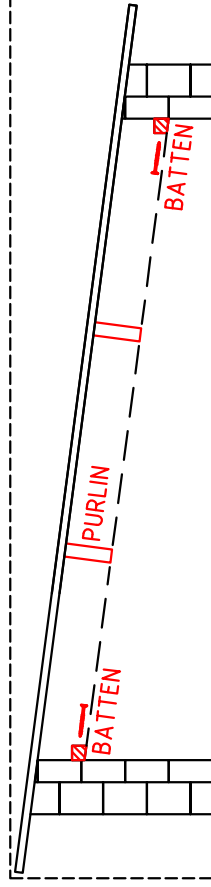

2. Place insulation sheets under purlins (use few left over screws from previous steps to hold sheets in place). Tape screw holes in sheets, connection seams and perimeter with aluminum tape.

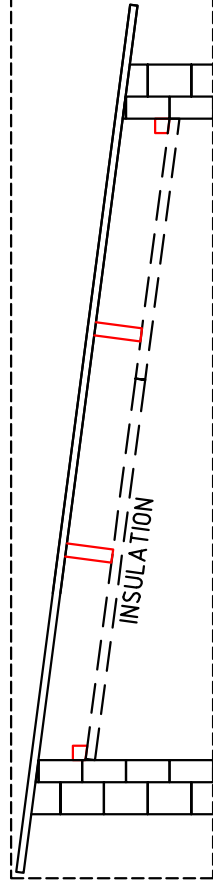

3. Fasten spacers under battens/purlins with 4,5x70 screws to secure insulation sheets properly in place.

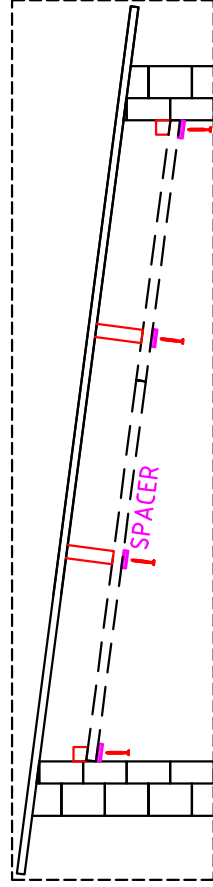

4. Fix ceiling boards under spacers with lost head nails (two nails for each connection). Finally fasten mouldings around perimeter using lost head nails.

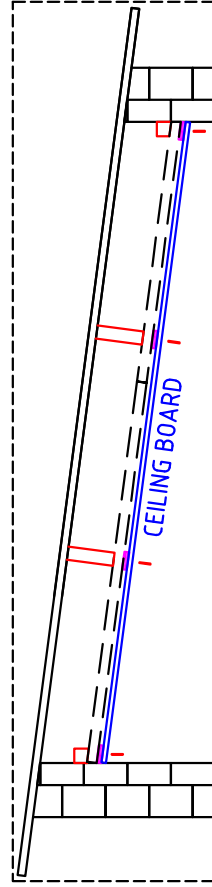

## CEILING INSULATION IN SAUNA ROOM

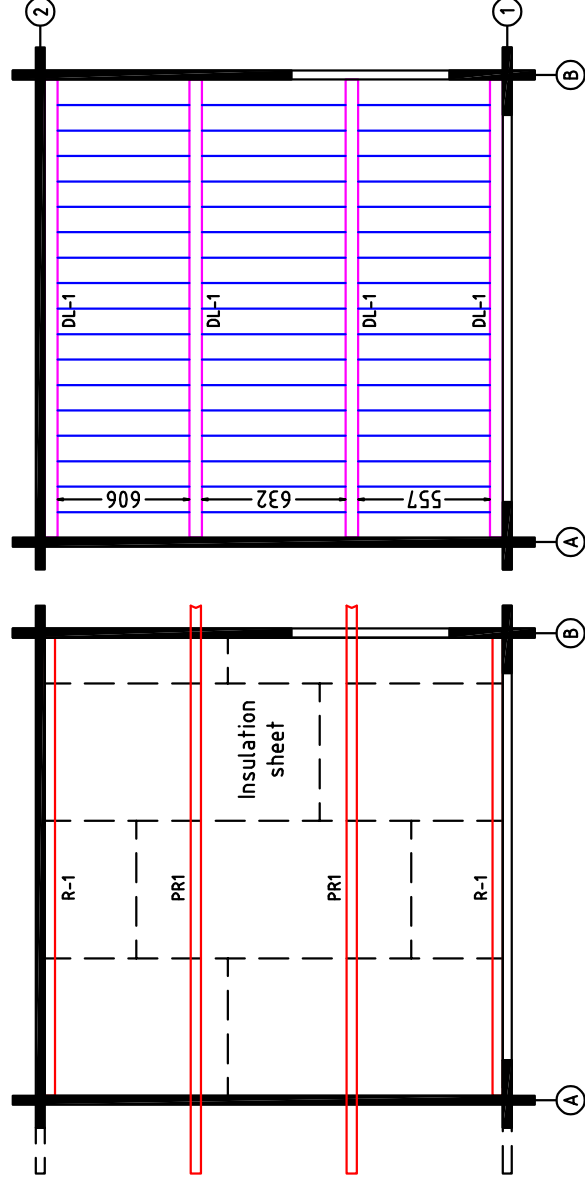
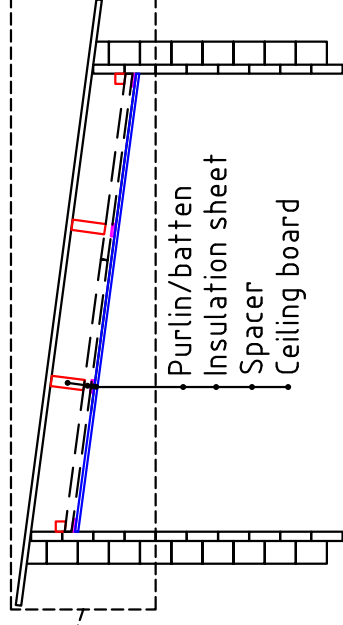

# FASTENING BENCH MODULES

This is an overall manual for bench modules. You can skip some of the steps depending on the set (for example if there is no bench skirt). Precise heights for bench supports and benches can be found on the next page.

1. Fasten bench supports with screws to wall. Use glue between wall and support for stronger connection.

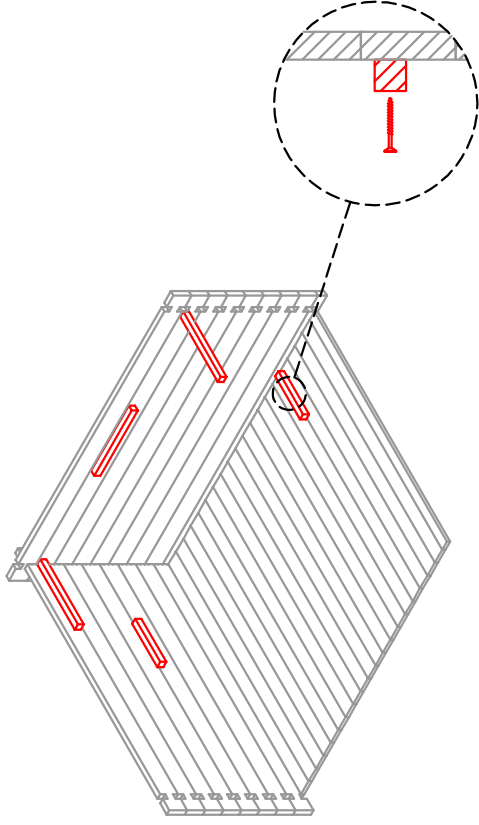

3. Lift bench skirt in place, attach it to wall from sides and to lower bench in middle. There should be 8mm gap between lower bench and bench skirt.

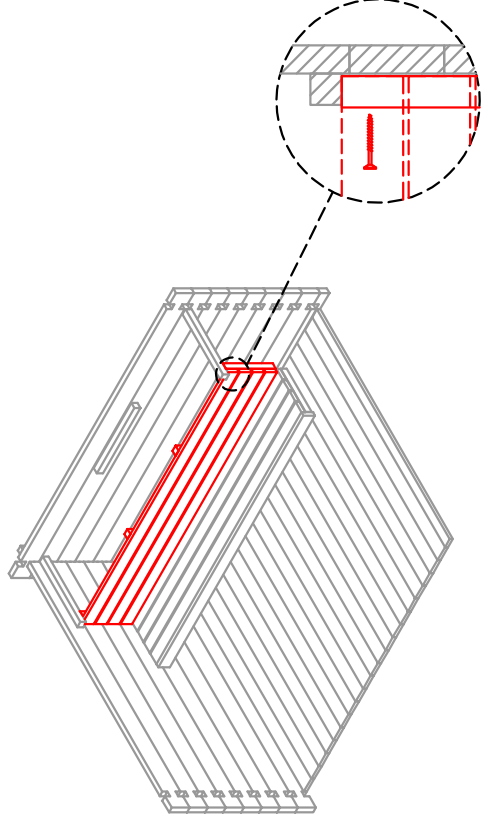

2. Lift modules in place and fix them to the supports on the walls. Do not install upper module in case there is bench skirt in set.

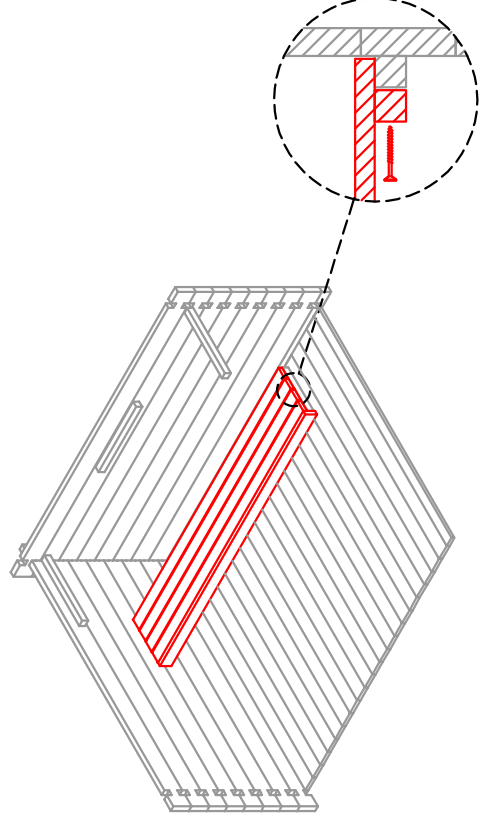

4. Place upper module and fix it in place as described in step two.

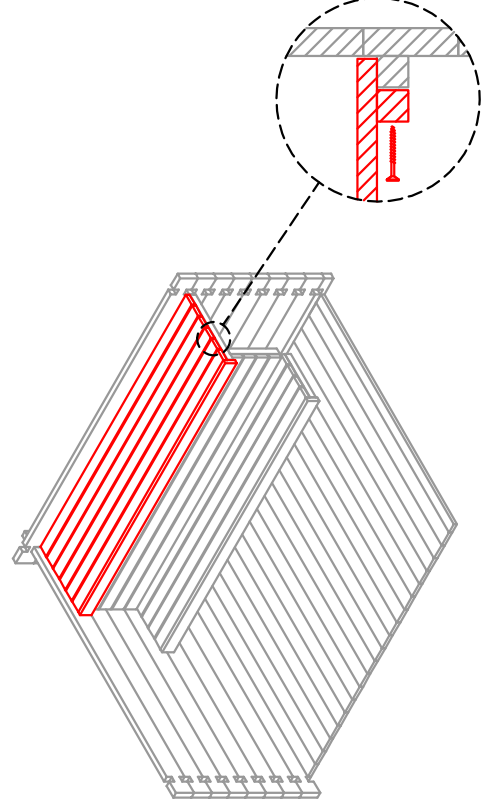

# CROSS-SECTION OF SAUNA ROOM AND HEIGHT OF BENCH MODULES

Use 4,5x70 screws to fasten bench supports to walls and to fix benches to already fixed supports. Lower module position is approximate (can be placed according to your own preference). Outdoor bench support must be fixed at the same height as is length of vertical supports.

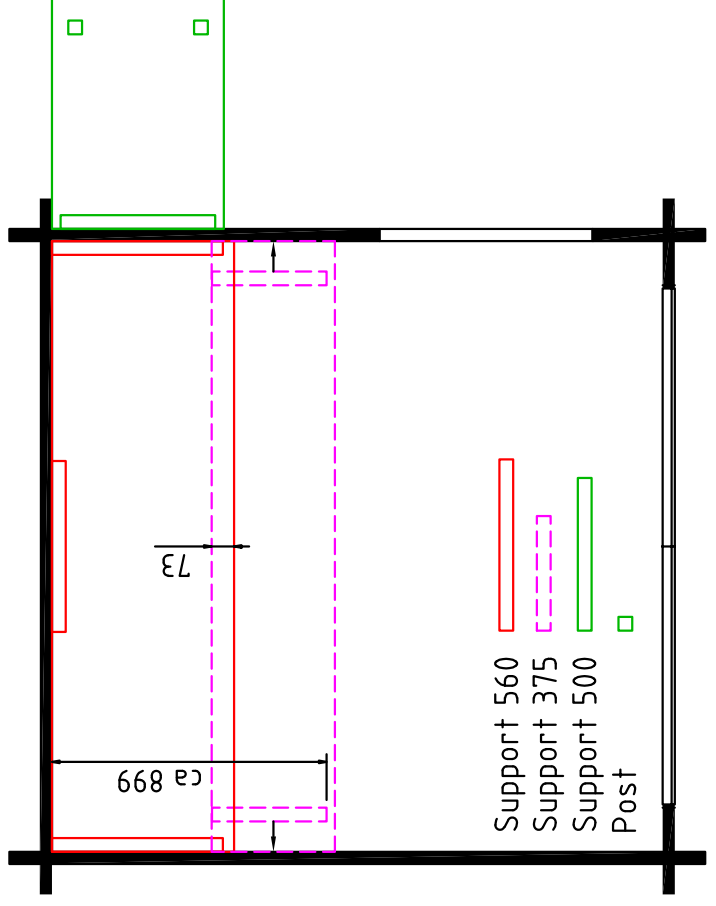
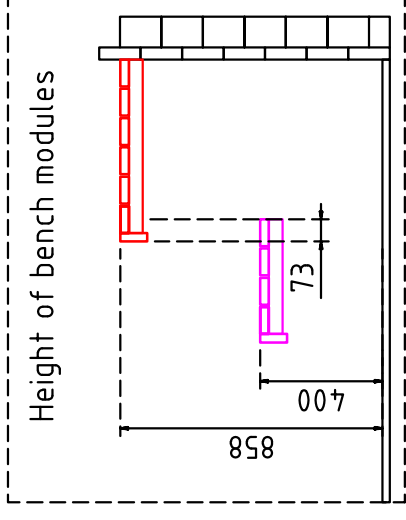
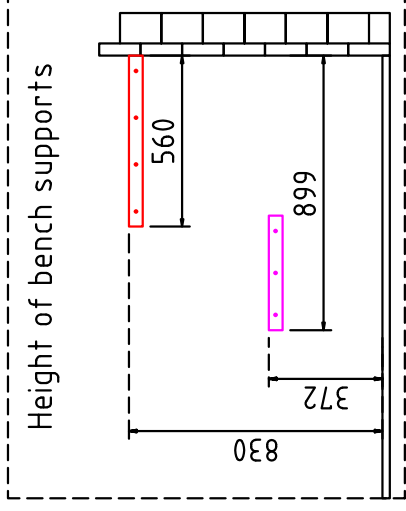
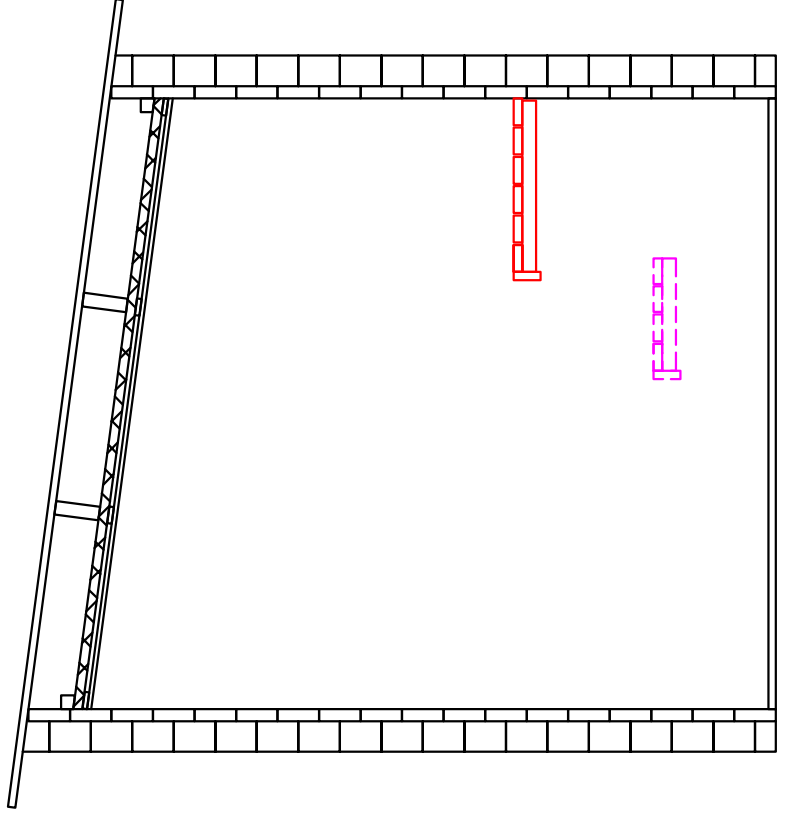

# FASTENING GRID WALLS AND ADJUSTING POSTS

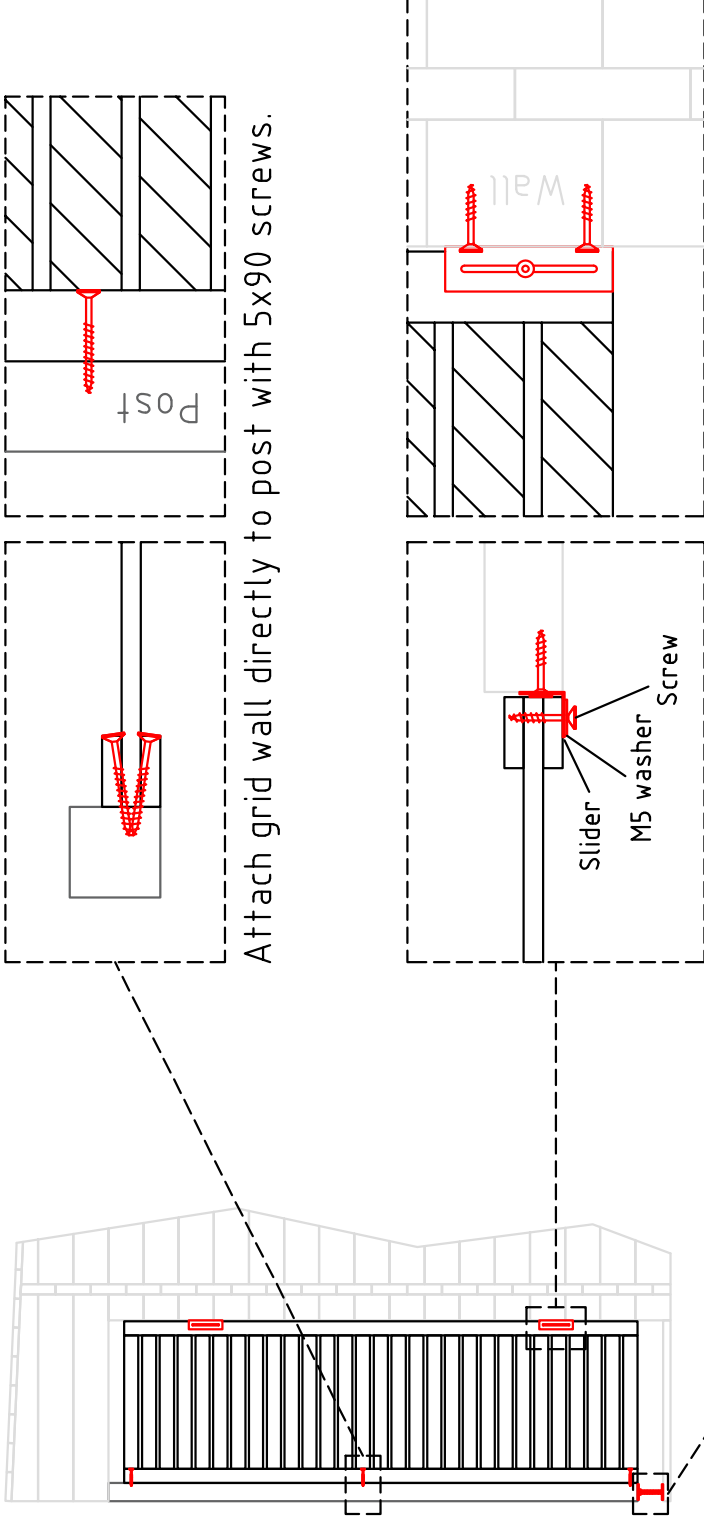

Attach grid wall directly to post with 5x90 screws.

Use sliding brackets to fix grid wall to house. Fasten slider to the wall logs. Leave the side with a slot on the side of grid wall, put M5 washer between screw and slider. Do not fix the screw too tight to enable the house to move different from grid wall.

After house is built it is necessary to adjust post support. Otherwise house will settle, but not the parts that are supported by post and there will be gaps between wall logs. Loosen nut under post and wait a little bit so house can settle. Then turn nut back against plate.

Adjusting should be done once a month after house has been built, then once every three months after half a year has passed and after first year it is enough to adjust post supports once or twice a year.