

HALDEN S 70 INSTALLATION DRAWINGS



HOUSE: HALDEN S 70

POS.	DESCRIPTION	NOTE	PCS.	PROFILE	LENGTH
AR4	IMPREGNATED FLOOR FRAMING		1	45x95	2914
AR3	IMPREGNATED FLOOR FRAMING	CUTOUT	1	45x95	2914
AR1	IMPREGNATED FLOOR FRAMING		10	45x95	2000
AR2	IMPREGNATED FLOOR FRAMING		1	45x70	2000
PL-1	FLOOR BOARD		18+2	24x112	1965
KL-1	ROOF BOARD		31+3	24x112	2728
SL-1	CEILING BOARD		18+2	14x111	2013
TL-1	IMPREGNATED TERRACE BOARD		17+2	28x120	800
TL-2	IMPREGNATED TERRACE BOARD		1	28x120	2118
PP-1	FLOOR/CEILING/ROOF MOULDING		11+1	15x55	2100
DL-1	SPACER		4	15x55	1996
R-1	BATTEN	BEVELLED	2	45x45	1996
RLT-1	ROOF EDGE SUPPORT		2	45x45	3464
RL-1	ROOF EDGE BOARD		2	18x95	3000
RL-2	ROOF EDGE BOARD		2+1	18x95	3600
APL55-1	MOULDINGS FOR 845+845x1792 WINDOW	1 SET	2	15x55	1762
APL95-1			2	18x95	1670
APL95-2			2	18x95	1920
APL95-3			4	18x95	1887
UPL95-1	MOULDINGS FOR 690x1860 DOOR	1 SET	2	18x95	920
UPL95-2			4	18x95	1890
UPL-1	EXTRA MOULDING		2	18x95	2400

	DESCRIPTION	NOTE	PCS.
DOORS/WINDOWS	EXTERIOR DOOR WITH WOODEN FRAME 70x690x1860		1
	WINDOW 70x845x1792		2
	DOOR HANDLE SET FOR EXTERIOR DOOR	WOODEN	1
	FIXING POST (TL-1)	1860MM	2
	FIXING POST (TL-2)	1792MM	2

HOUSE: HALDEN S 70

	DESCRIPTION	NOTE	PCS.
COMPONENTS	BENCH MODULE 600x1992		1
	BENCH MODULE 400x1992		1
	BENCH SUPPORTS SET 45x45 (560-3PCS, 500-1PC, 452-2PCS, 375-2PCS)		1
	ADDITIONAL VERTICAL BENCH SUPPORT 45x45x1000	ADJUSTABLE	1
	OUTDOOR BENCH 563x750		1
	GRID WALL 650x1711		1
	3MM SLOPE BOARD	1996MM	1
	6MM SLOPE BOARD	1996MM	1
	9MM SLOPE BOARD	1996MM	1
	12MM SLOPE BOARD	1996MM	1
	INSULATION SHEET 30x600x1200		6
	ALUMINUM TAPE		20M
	WOODEN VENTILATION LOUVER D100		2
	METAL VENTILATION GRID D100		2
	DRAINAGE 2000+	OPENS RIGHT	1
	SPRAY FOAM FOR DOORS/WINDOWS		1

HOUSE: HALDEN S 70

POS.	DESCRIPTION	PCS.	LENGTH
KL1	THREADED ROD M10	2	2490
KL2	THREADED ROD M10	2	2195
	METAL PLATE M10 (40x40x5)	4	
	LENGTHENING BOLT M10	4	
	WASHER M10	4	
	NUT M10	4	

	DESCRIPTION	PCS.	
FASTENERS	3.5x50 SCREW FOR FLOOR BOARDS	200	
	3x40 STAINLESS SCREW FOR DOOR/WINDOW MOULDINGS	150	
	4.2x55 STAINLESS SCREW FOR TERRACE AND ROOF EDGE BOARDS	200	
	4.5x60 SCREW FOR ROOF EDGE SUPPORT	40	
	5x40 SCREW FOR SLIDING BRACKETS	10	
	5x90 SCREW FOR FLOOR FRAMING, CONNECTING WALL LOGS WITH FLOOR FRAMING, BENCH MODULES, CEILING INSULATION AND GRID WALL	150	
	6x180 SCREW FOR PURLINS, CONNECTING WALL LOGS WITH FLOOR FRAMING AND WALL LOGS	30	
	6x70 DOOR/WINDOW FRAME SCREWS		
	75MM NAIL FOR ROOF BOARDS	300	
	40MM LOST HEAD NAIL FOR CEILING BOARDS	250	
	ADJUSTABLE POST SUPPORT 60x60	1	
	SLIDING BRACKET 35x35x130	2	
	WASHER M5 FOR GRID WALL	2	

BASE PLAN

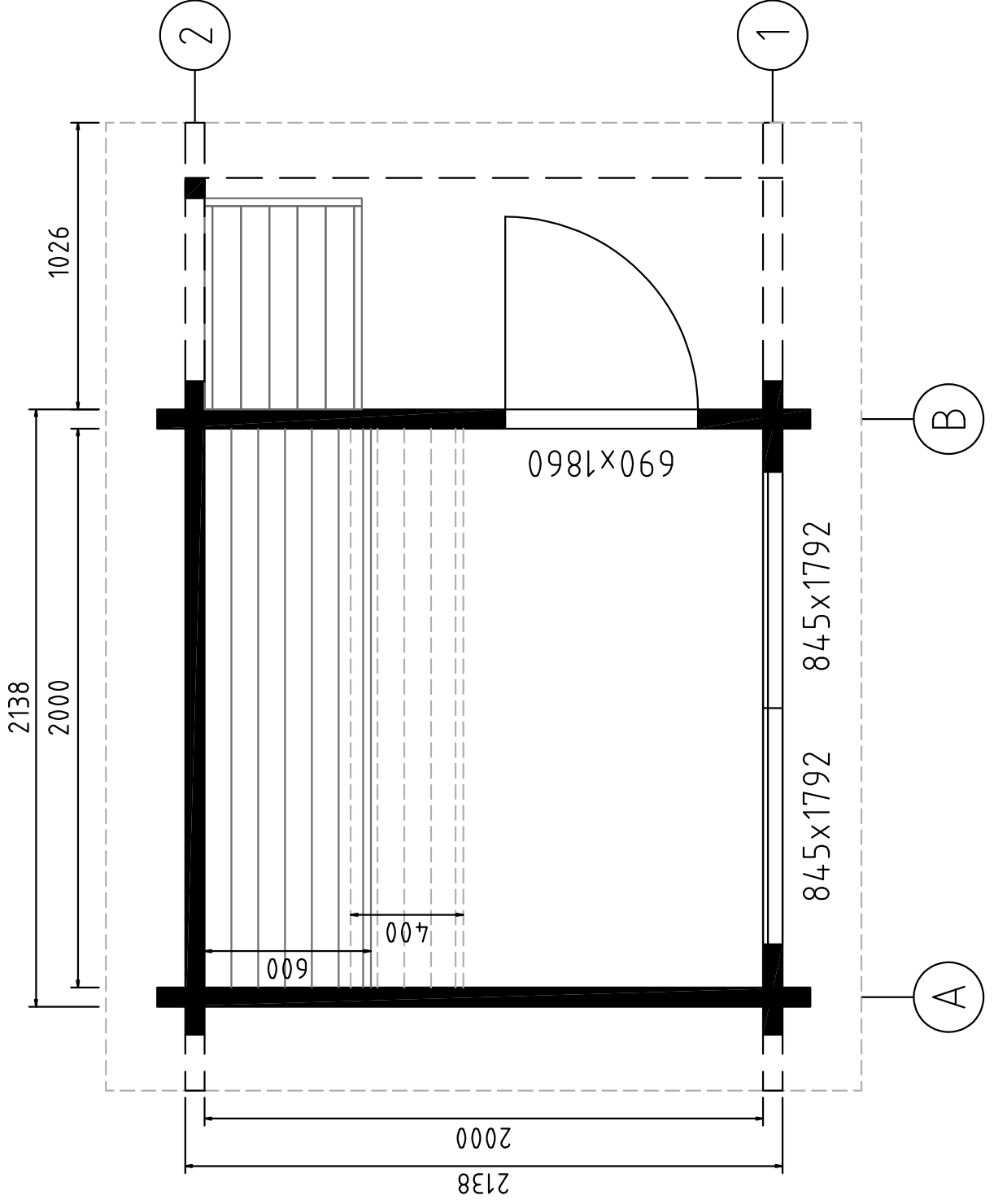

FLOOR FRAMING 45x95

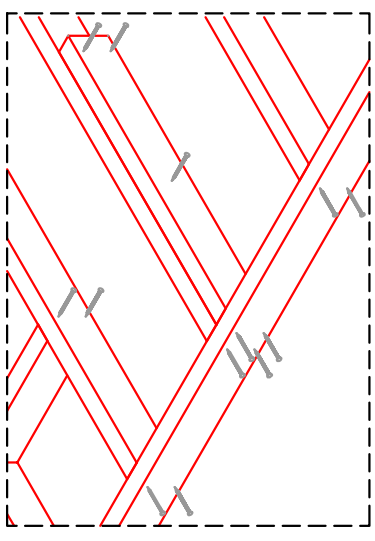
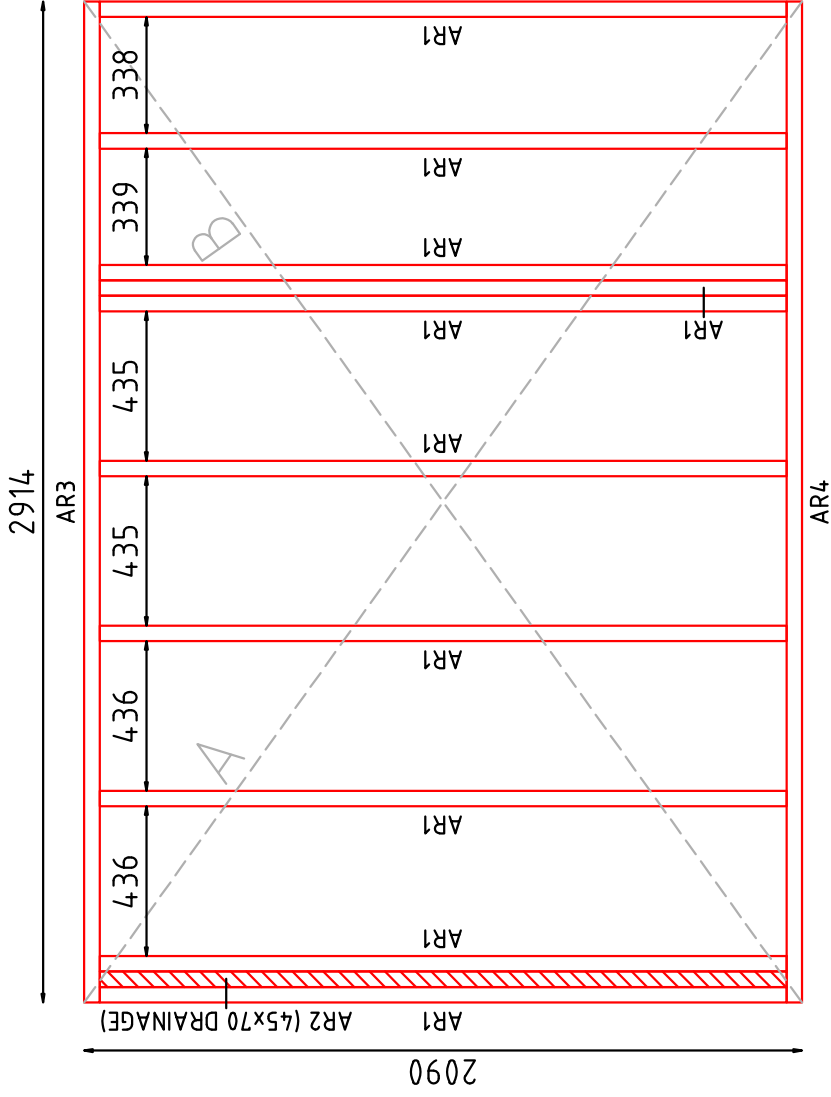

Use two 5x90 screws to fasten joist ends with crossing joists. Fix with parallel joists, when there is no crossing joists.

NB! Check diagonals, remember that A=B=3586

FASTENING WALL LOGS

Fasten first row to floor framing. Use 5x90 screws for half logs (fix those first) and 6x180 screws for full logs. It is recommended to predrill holes. If necessary use rubber hammer and hit block to secure logs tightly on top of each other.

When placing wall logs check that there are holes in the end of logs for threaded rods (marked with KL on wall layout views). If there is no hole, drill it before placing next row of wall logs.

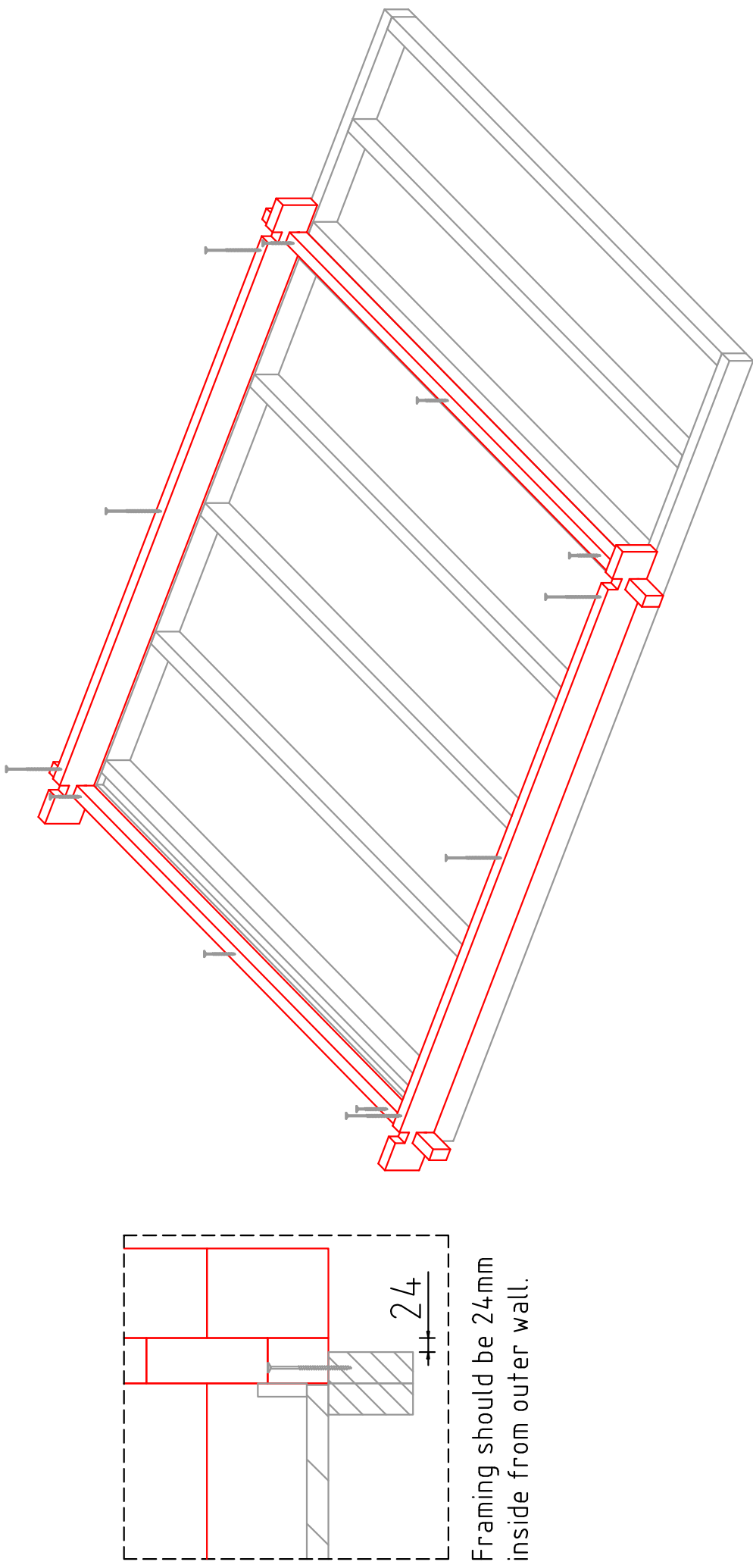

WALL A

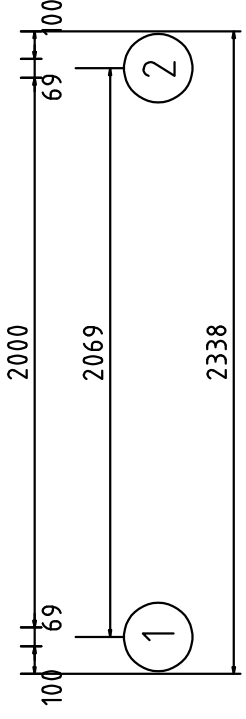
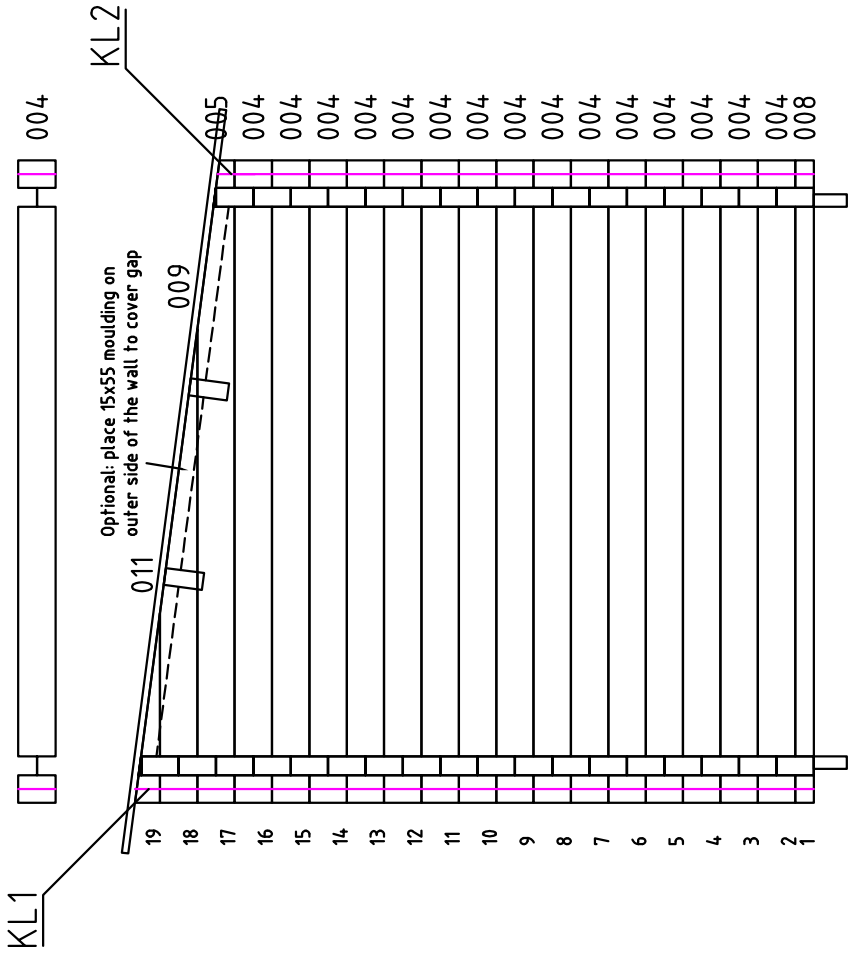

WALL B

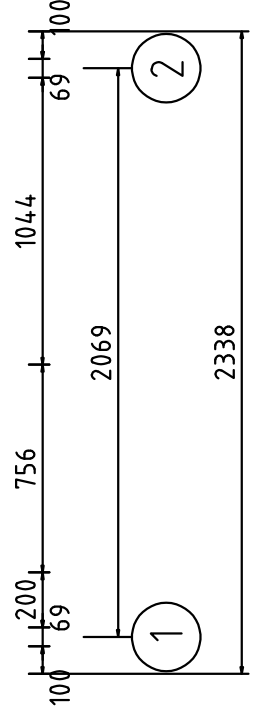
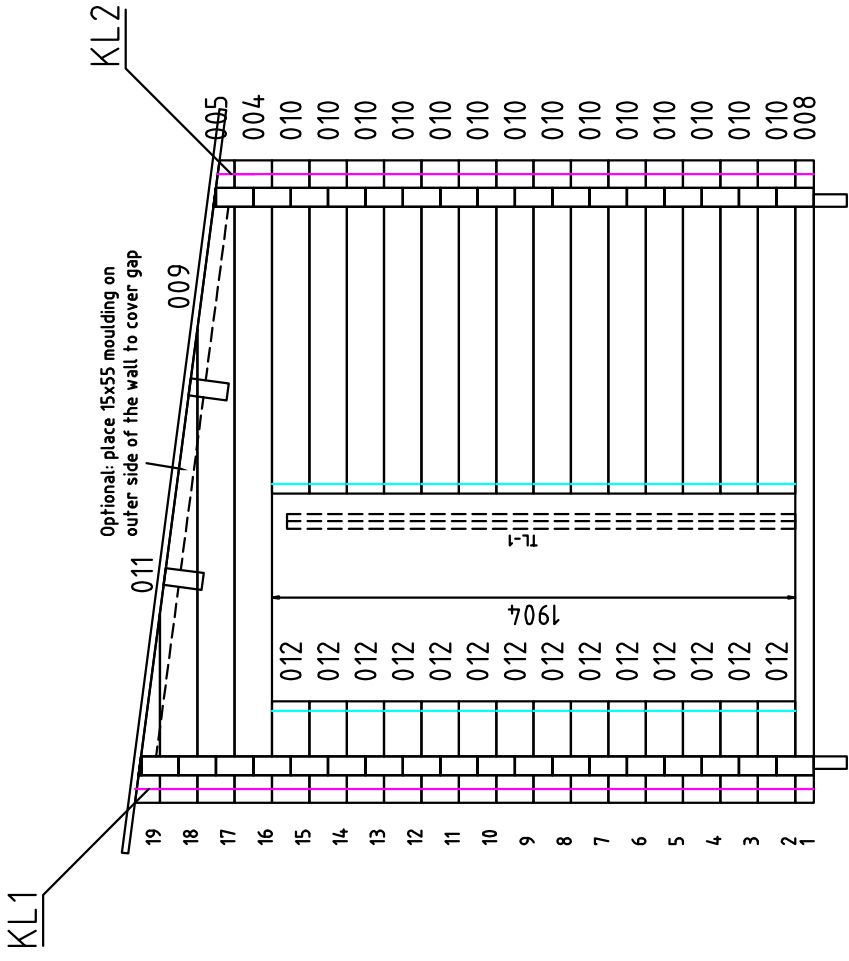

WALL 2

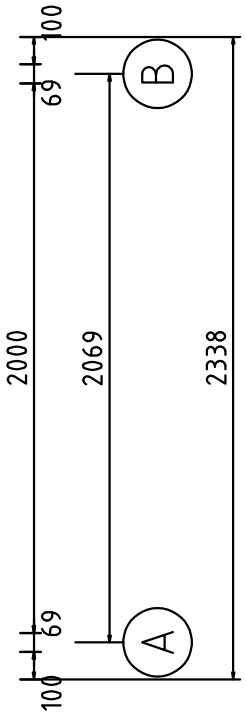
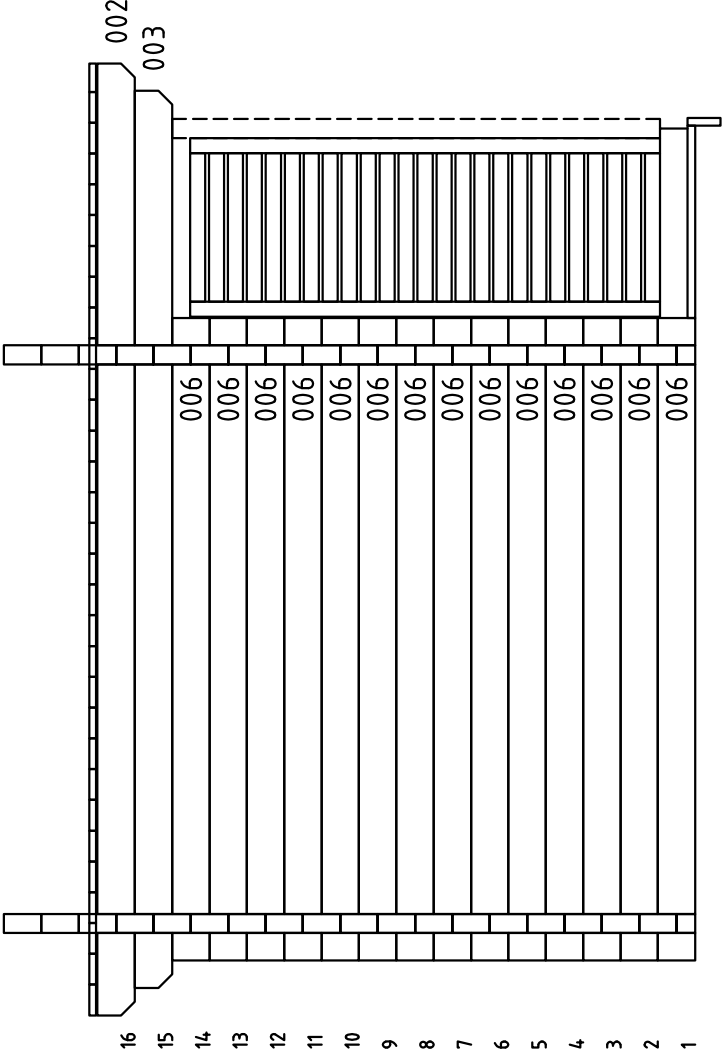

PLACING AND TIGHTENING THREADED RODS

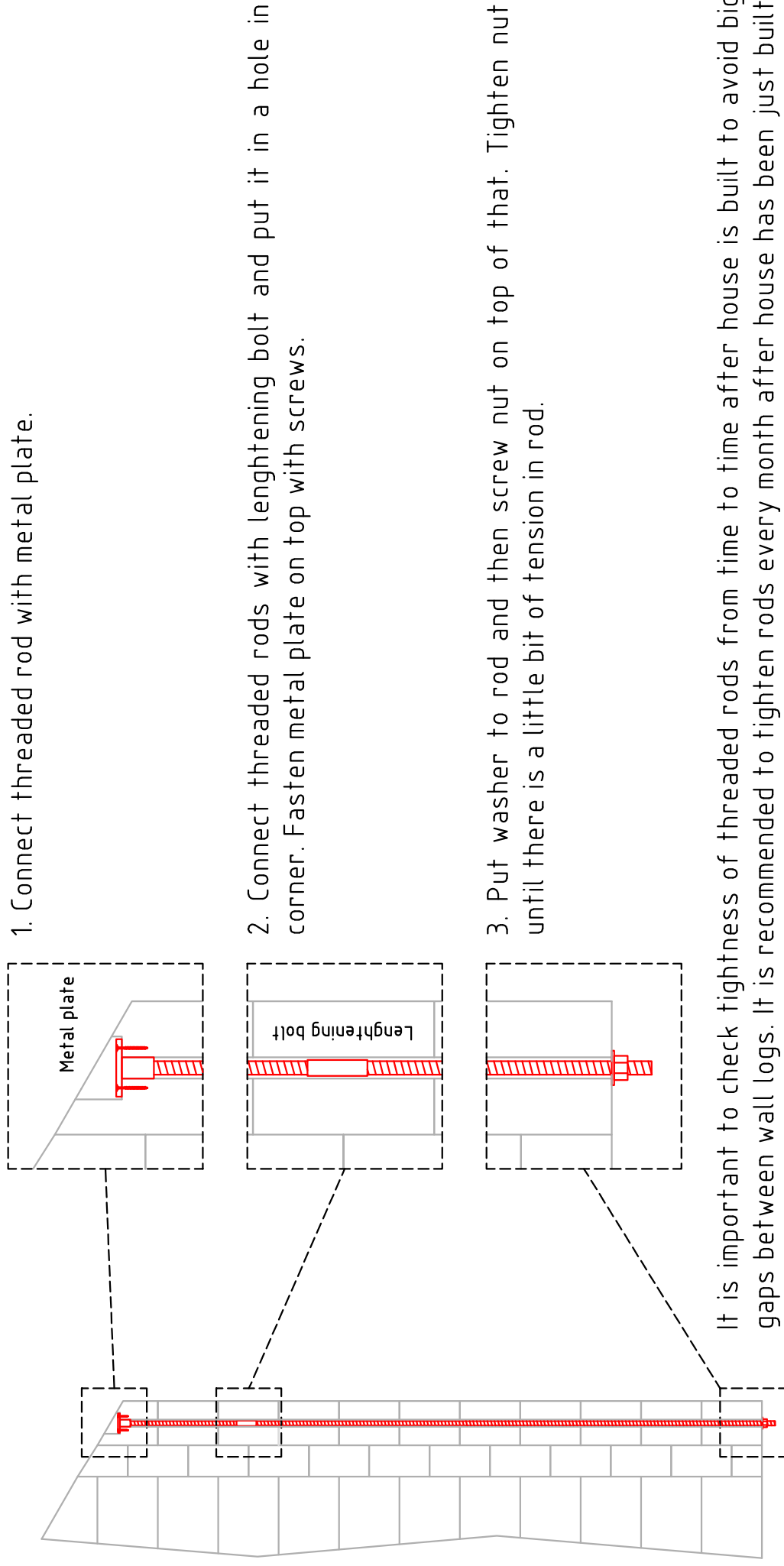

It is important to check tightness of threaded rods from time to time after house is built to avoid big gaps between wall logs. It is recommended to tighten rods every month after house has been just built. Later it can be done twice a year. To tighten rod, turn nut against wood using fingers and then use wrench to add more tension. Avoid turning wrench with hard force, because it can ruin threads on rod and make it impossible to tighten it in the future.

Add slope boards and drainage details before fixing floor boards.

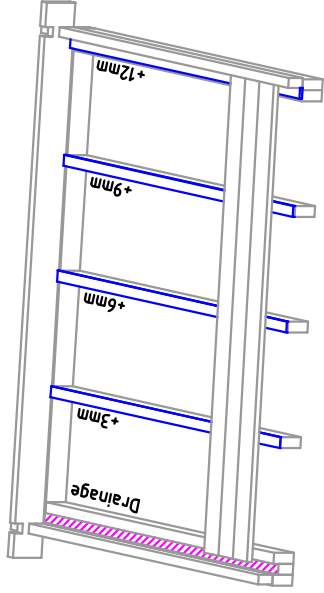

When placing drainage, fix closed end temporarily ~5mm higher than opened end to guarantee slope towards outer wall for water. After placing floor boards fix it permanently with floor mouldings.

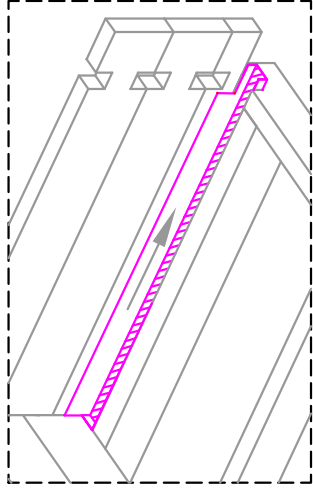

FLOOR BOARDS

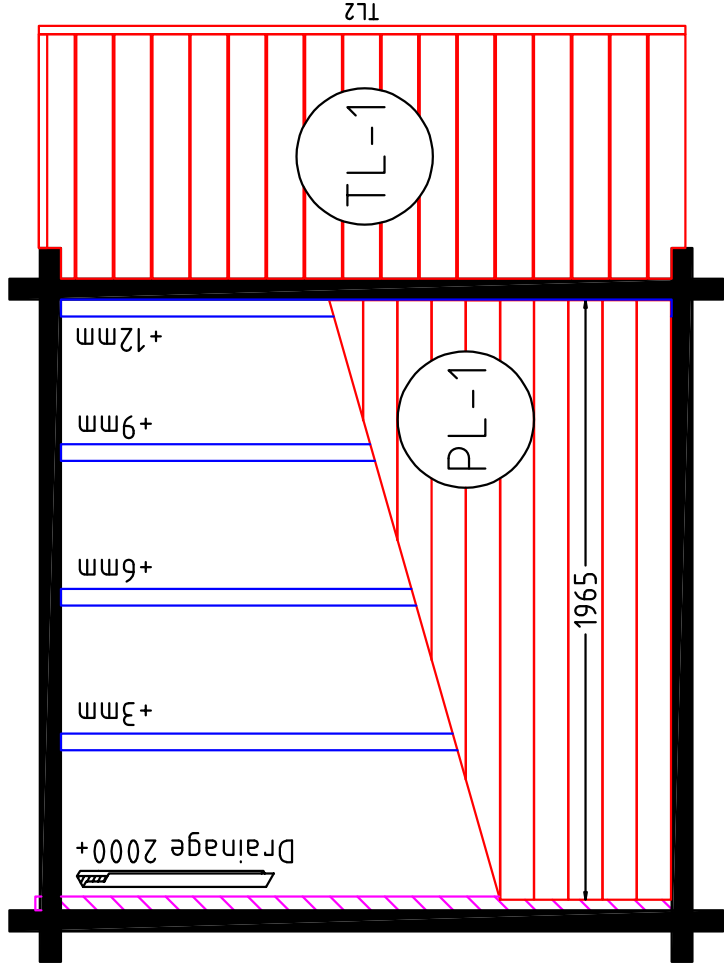

Fasten floor boards with screws from the tongue side of the board. First board should be placed ~5mm from wall and when cutting last board make sure there is 5mm gap as well. Leave ~2mm gap between floor board (cross cut sides) and walls. Lastly fix mouldings in place.

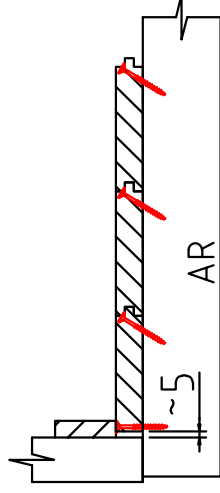

Fasten terrace boards with two screws in each connection.

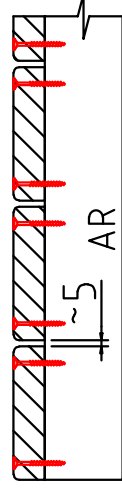

1. Fix purlins with 6x180 screws (pre-drill holes).

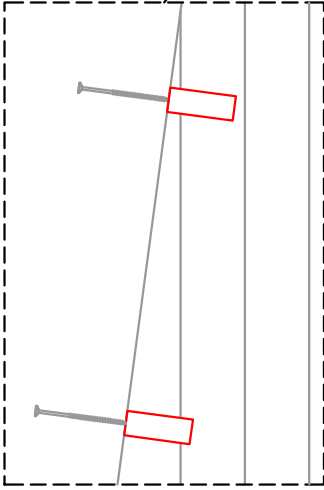

2. Fix roof boards with 75mm nails (2pcs for each connection).

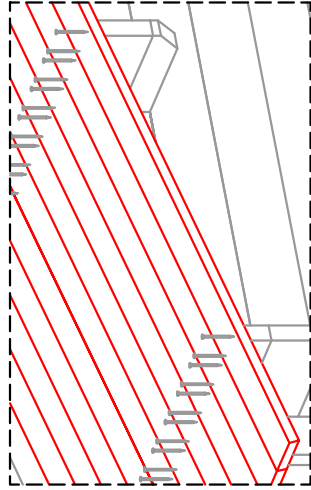

3. Fasten roof edge support and board. Use 4,5x60 screws (one for every other board ending) to fix edge support. For edge boards use 4,2x55 screws.

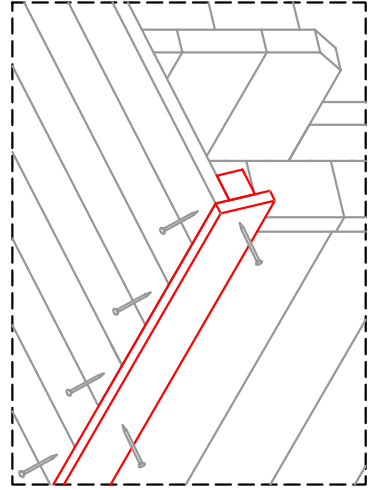

ROOF BOARDS

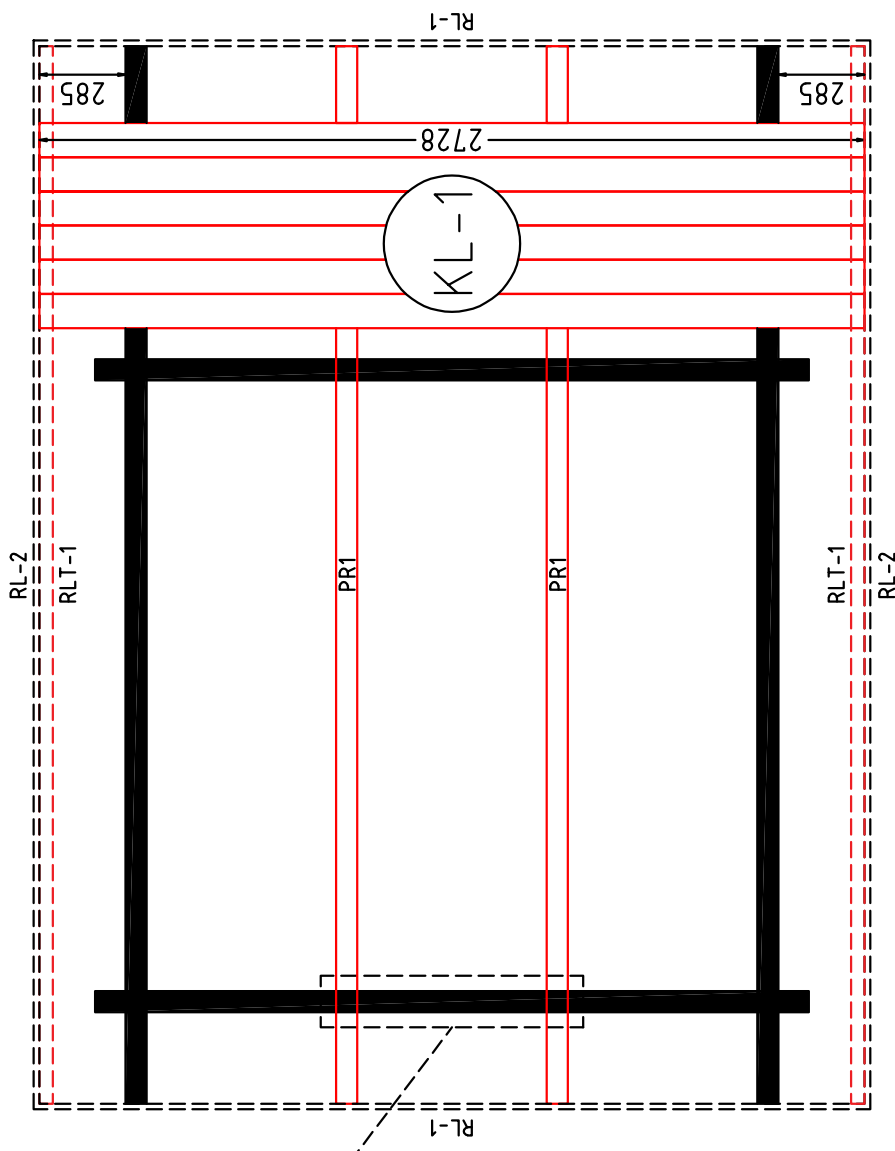

4. Cut gable edge boards to length and fix with 4,2x55 screws.

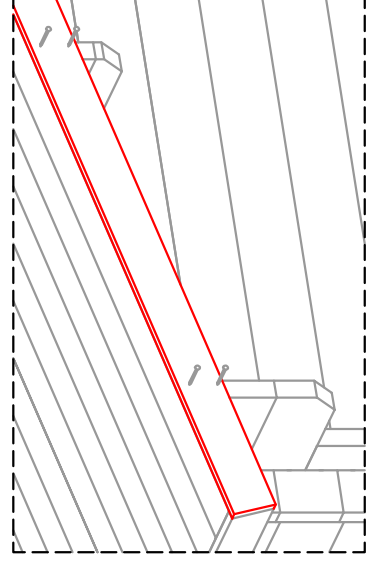

FASTENING DOORS/WINDOWS

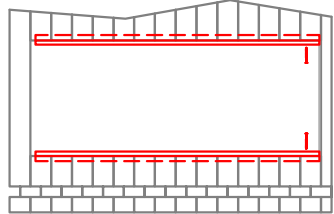

1. Place fixing post in opening. Screw it to wall with only one 5x90 screw in lower part of the post (about 100mm from bottom). Do not screw in upper part so that house can settle.

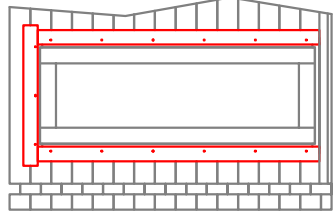

4. Fasten upper moulding to frame (not to wall) with 3x40 stainless screws. Upper moulding should cover about 20mm of frame.

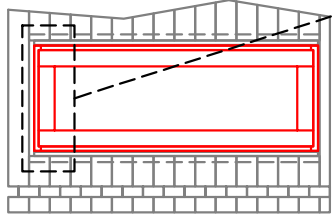
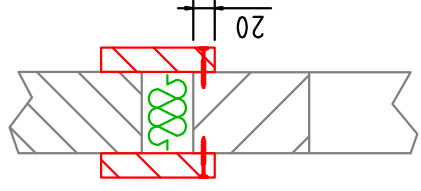

2. Fix door/window in place by screwing 6x70 frame screws to fixing post from holes in frame.

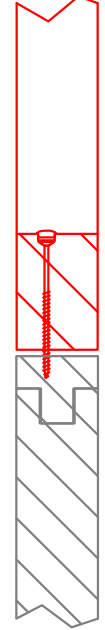

3. Use spray foam to fill the gap above.

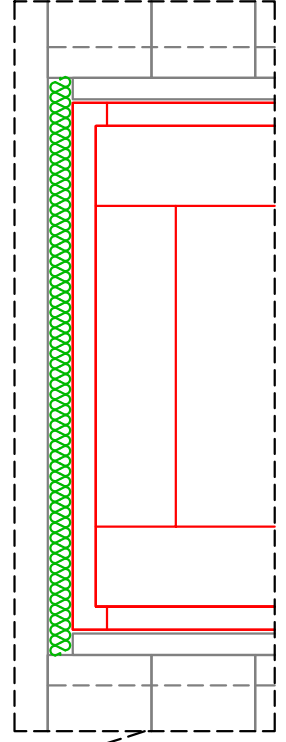

5. Fasten side mouldings to fixing post with 3x40 screws. Side moulding coverage should be about 10mm. Bottom moulding can be screwed directly to wall.

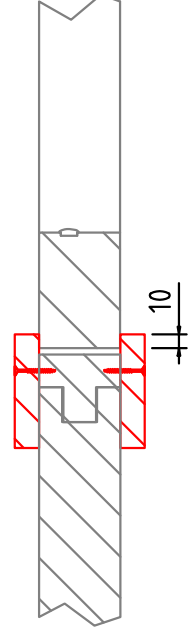

DOOR/WINDOW MOULDINGS

EXTERIOR DOOR
70x690x1860

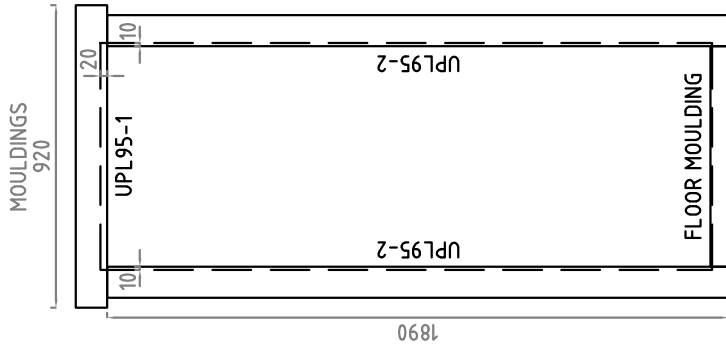
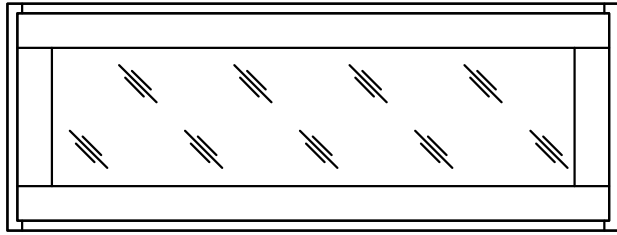

WINDOW 70x845+845x1792

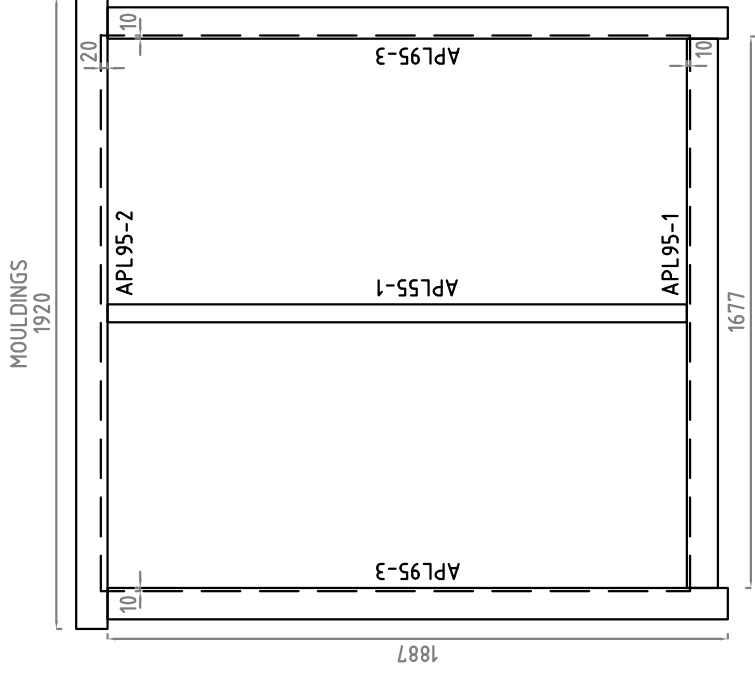
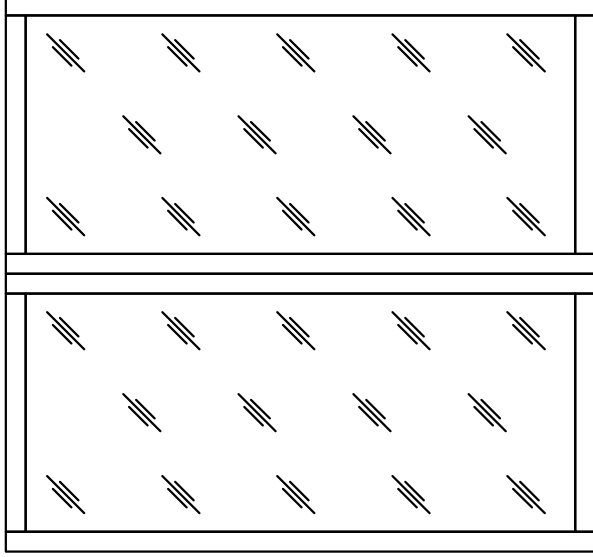

CEILING INSULATION IN SAUNA ROOM

1. Fasten battens (R-1) to side walls so that they are in line with purlins. Use 5x90 screws.

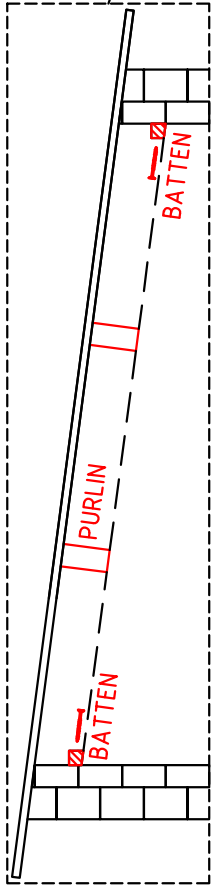

2. Place insulation sheets under purlins (use few left over screws from previous steps to hold sheets in place). Tape screw holes in sheets, connection seams and perimeter with aluminum tape.

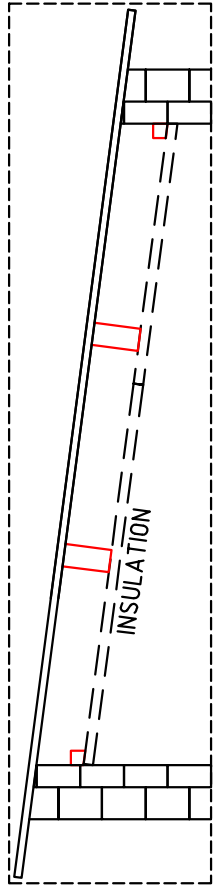

3. Fasten spacers under battens/purlins with 5x90 screws to secure insulation sheets properly in place.

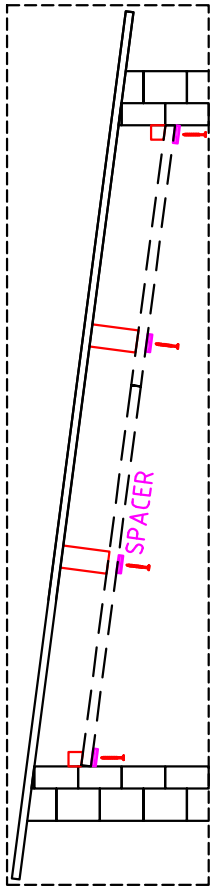

4. Fix ceiling boards under spacers with lost head nails (two nails for each connection). Finally fasten mouldings around perimeter using lost head nails.

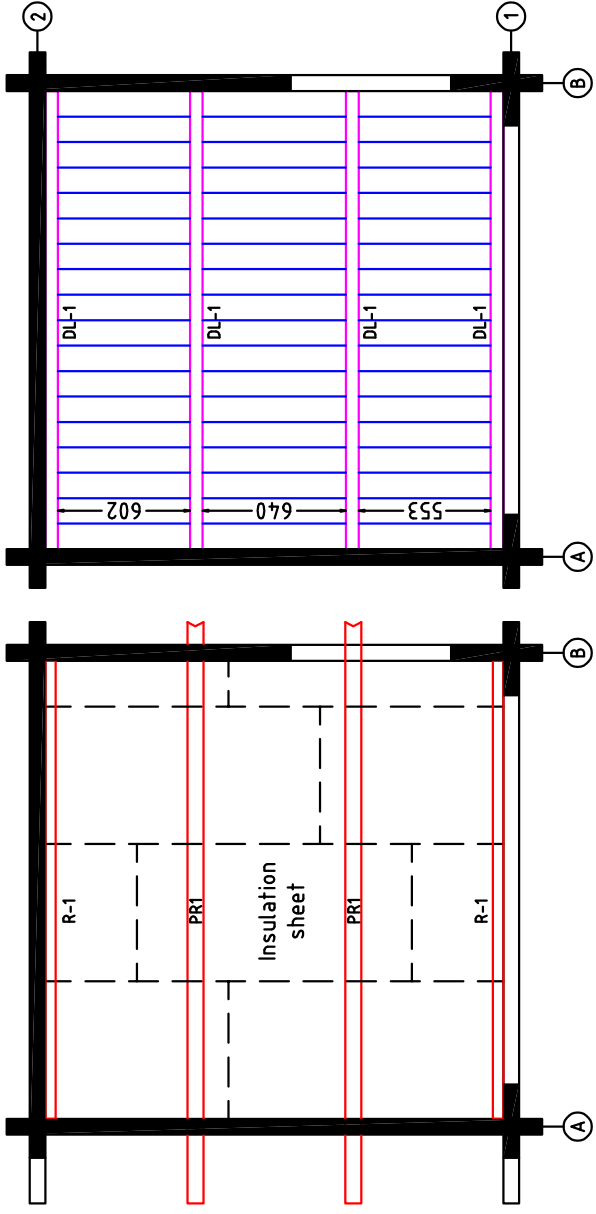
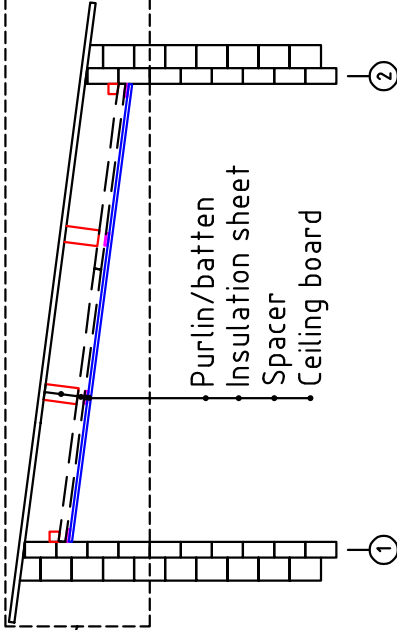
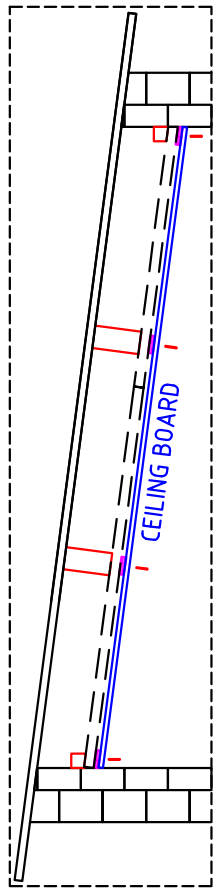

FASTENING BENCH MODULES

This is an overall manual for bench modules. You can skip some of the steps depending on the set (for example if there is no bench skirt). Precise heights for bench supports and benches can be found on the next page.

1. Fasten bench supports with screws to wall. Use glue between wall and support for stronger connection.

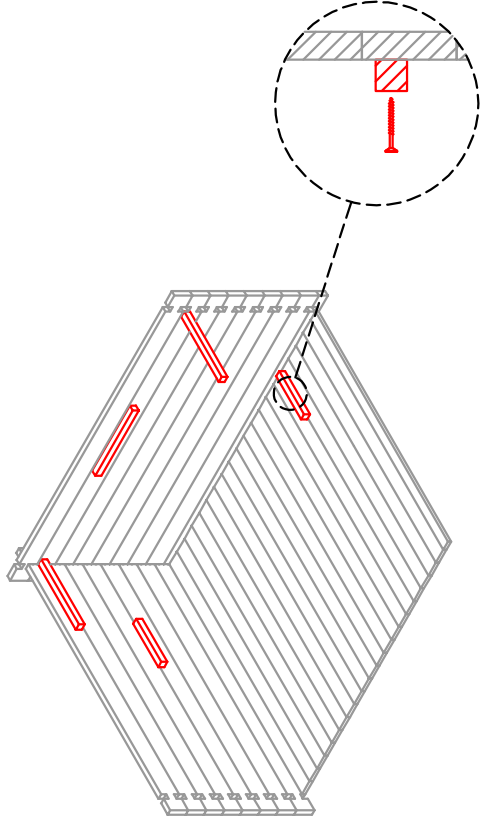

3. Lift bench skirt in place, attach it to wall from sides and to lower bench in middle. There should be 8mm gap between lower bench and bench skirt.

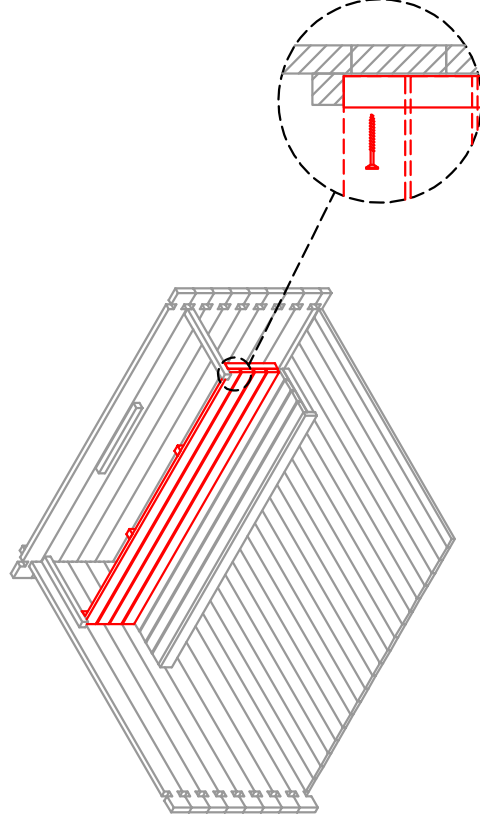

2. Lift modules in place and fix them to the supports on the walls. Do not install upper module in case there is bench skirt in set.

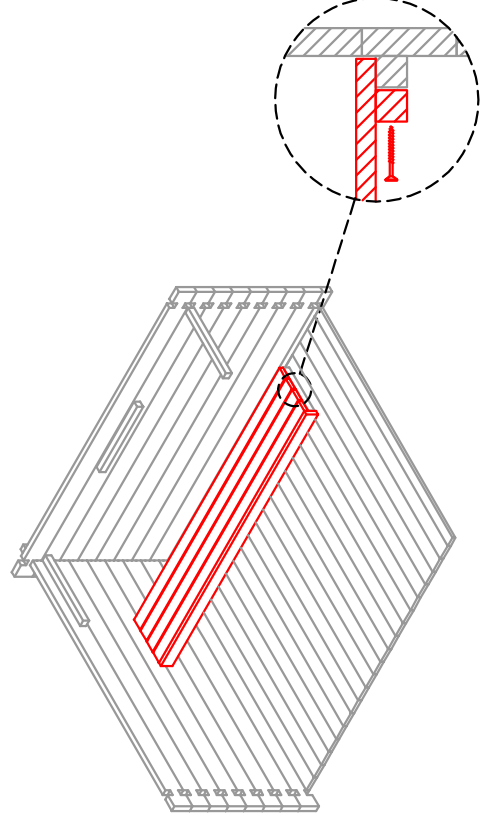

4. Place upper module and fix it in place as described in step two.

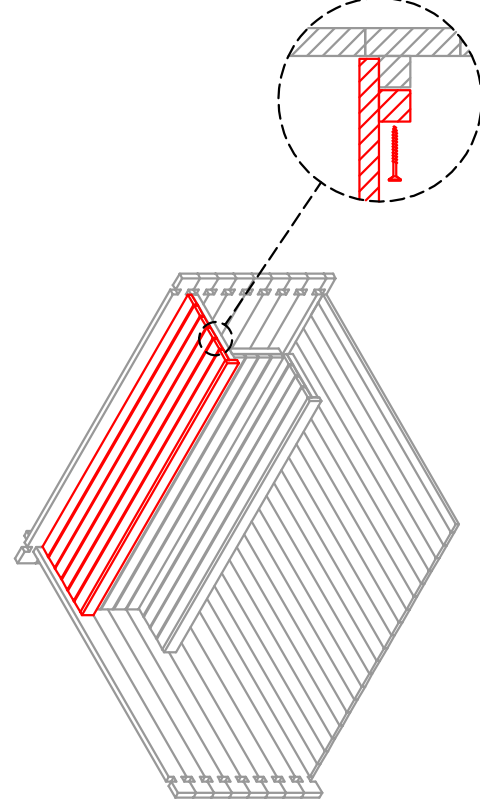

CROSS-SECTION OF SAUNA ROOM AND HEIGHT OF BENCH MODULES

Use 5x90 screws to fasten bench supports to walls and to fix benches to already fixed supports. Distance of the lower module from the wall is not fixed, it can be placed according to your own preference. Outdoor bench support must be fixed at the same height as is the length of the vertical supports.

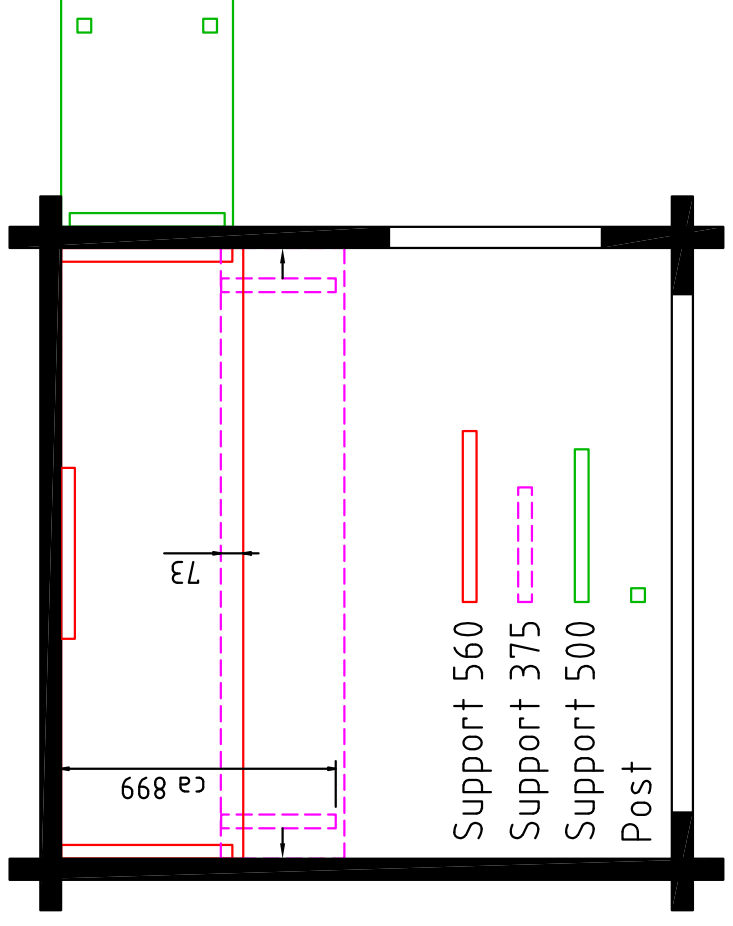
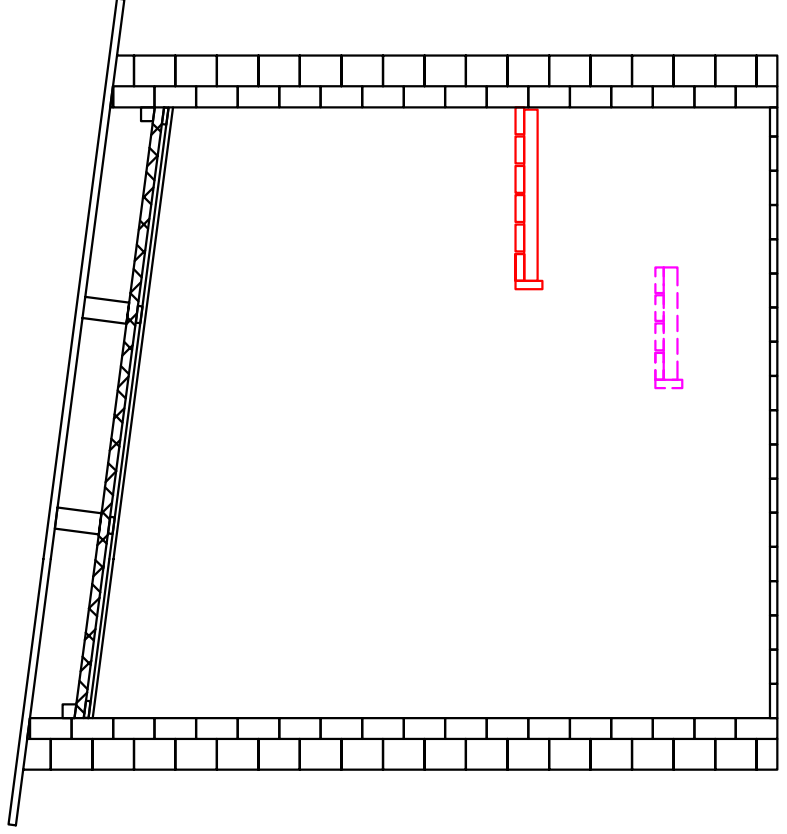
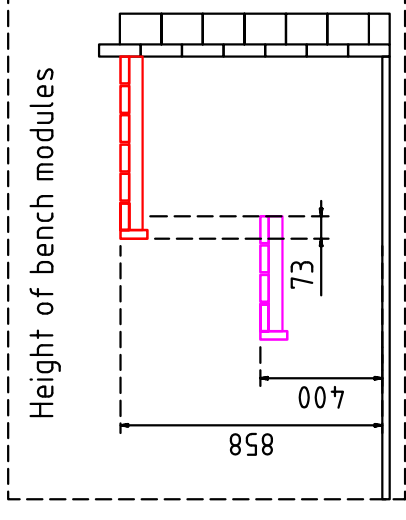
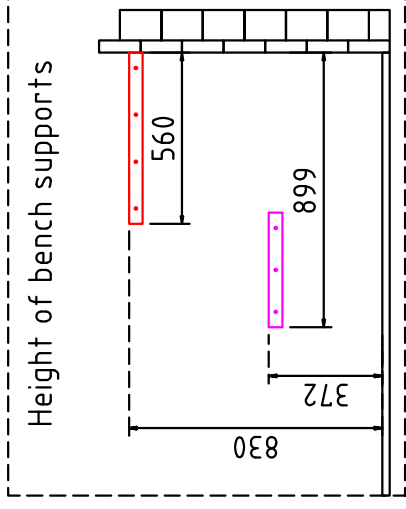

FASTENING GRID WALLS AND ADJUSTING POSTS

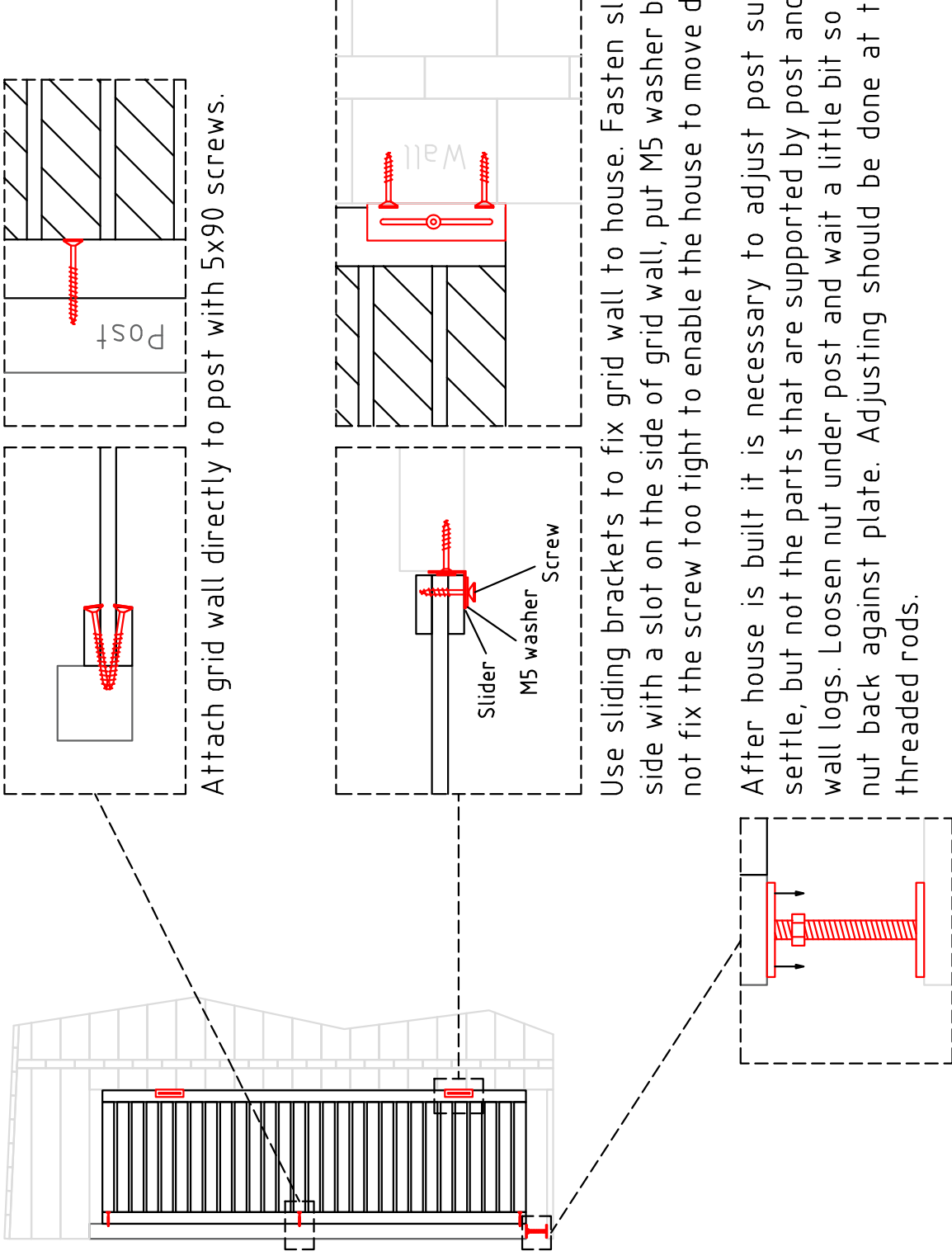

Use sliding brackets to fix grid wall to house. Fasten slider to wall logs. Leave the side with a slot on the side of grid wall, put M5 washer between screw and slider. Do not fix the screw too tight to enable the house to move different from grid wall.

After house is built it is necessary to adjust post support. Otherwise house will settle, but not the parts that are supported by post and there will be gaps between wall logs. Loosen nut under post and wait a little bit so house can settle. Then turn nut back against plate. Adjusting should be done at the same time as tightening threaded rods.